

# 4.8 V NPN Common Emitter Medium Power Output Transistor

## Technical Data

### AT-31625

#### Features

- 4.8 Volt Operation
- +28.0 dBm  $P_{out}$  @ 900 MHz, Typ.
- 70% Collector Efficiency @ 900 MHz, Typ.
- 9 dB Power Gain @ 900 MHz, Typ.
- -31 dBc  $IMD_3$  @  $P_{out}$  of 21 dBm per Tone, 900 MHz, Typ.
- 50% Smaller than SOT-223 Package

#### Applications

- Medium Power Driver Device for Cellular/PCS, ISM 900, WLAN
- Output Power Device for ISM 900, Cordless, WLAN

#### MSOP-3 Surface Mount Plastic Package Outline 25

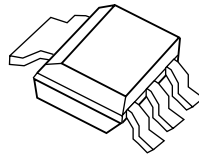

#### Pin Configuration

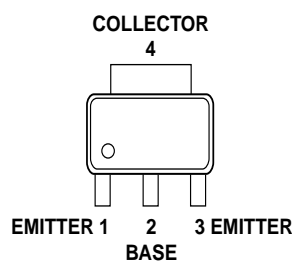

#### Description

Hewlett Packard's AT-31625 is a low cost, NPN medium power silicon bipolar junction transistor housed in a miniature, MSOP-3 surface mount plastic package. The AT-31625 can be used as a driver device or an output device, depending on the specific application. The AT-31625 features +28 dBm CW output power when operated at 4.8 volts. Excellent gain and superior efficiency make the AT-31625 ideal for use in battery powered systems.

The AT-31625 is fabricated with Hewlett Packard's 10 GHz  $F_t$  Self-Aligned-Transistor (SAT) process. The die are nitride passivated for surface protection. Excellent device uniformity, performance and reliability are produced by the use of ion-implantation, self-alignment techniques, and gold metalization in the fabrication of these devices.

## AT-31625 Absolute Maximum Ratings

Symbol	Parameter	Units	Absolute Maximum <sup>[1]</sup>
V <sub>EBO</sub>	Emitter-Base Voltage	V	1.4
V <sub>CBO</sub>	Collector-Base Voltage	V	16.0
V <sub>CEO</sub>	Collector-Emitter Voltage	V	9.5
I <sub>C</sub>	Collector Current	mA	320
P <sub>T</sub>	Power Dissipation <sup>[2]</sup>	W	1.0
T <sub>j</sub>	Junction Temperature	°C	150
T <sub>STG</sub>	Storage Temperature	°C	-65 to 150

### Thermal Resistance<sup>[3]</sup>:

$$\theta_{jc} = 65^{\circ}\text{C/W}$$

#### Notes:

1. Permanent damage may occur if any of these limits are exceeded.
2. Derate at 15.4 mW/°C for T<sub>c</sub> > 85°C. T<sub>c</sub> is defined to be the temperature of the collector pin 4, where the lead contacts the circuit board.
3. Using the liquid crystal technique, V<sub>CE</sub> = 4.8 V, I<sub>C</sub> = 50 mA, T<sub>j</sub> = 150°C, 1-2 μm "hot-spot" resolution.

## Electrical Specifications, T<sub>C</sub> = 25°C

Symbol	Parameters and Test Conditions	Units	Min.	Typ.	Max.
	Freq. = 900 MHz, V <sub>CE</sub> = 4.8 V, I <sub>CQ</sub> = 5 mA, CW operation, Test Circuit A, unless otherwise specified				
P <sub>out</sub>	Output Power <sup>[1]</sup> P <sub>in</sub> = +19 dBm	dBm	+27.0	+28.0	
η <sub>C</sub>	Collector Efficiency <sup>[1]</sup> P <sub>in</sub> = +19 dBm	%	55	70	
IMD <sub>3</sub>	3rd Order Intermodulation Distortion, 2 Tone Test, P <sub>out</sub> each Tone = +21 dBm <sup>[1]</sup> F1 = 899 MHz F2 = 901 MHz	dBc		-31	
	Mismatch Tolerance, No Damage <sup>[1]</sup> P <sub>out</sub> = +28 dBm any phase, 2 sec duration				7:1
BV <sub>EBO</sub>	Emitter-Base Breakdown Voltage I <sub>E</sub> = 0.2 mA, open collector	V	1.4		
BV <sub>CBO</sub>	Collector-Base Breakdown Voltage I <sub>C</sub> = 1.0 mA, open emitter	V	16.0		
BV <sub>CEO</sub>	Collector-Emitter Breakdown Voltage I <sub>C</sub> = 5.0 mA, open base	V	9.5		
h <sub>FE</sub>	Forward Current Transfer Ratio V <sub>CE</sub> = 3 V, I <sub>C</sub> = 180 mA	—	80	150	330
I <sub>CEO</sub>	Collector Leakage Current V <sub>CEO</sub> = 5 V	μA			15

#### Note:

1. With external matching on input and output, tested in a 50 ohm environment. Refer to Test Circuit A.

## AT-31625 Typical Performance, $T_C = 25^\circ\text{C}$

Frequency = 900 MHz,  $V_{CE} = 4.8\text{ V}$ ,  $I_{CQ} = 5\text{ mA}$ , CW operation, Test Circuit A, unless otherwise specified.

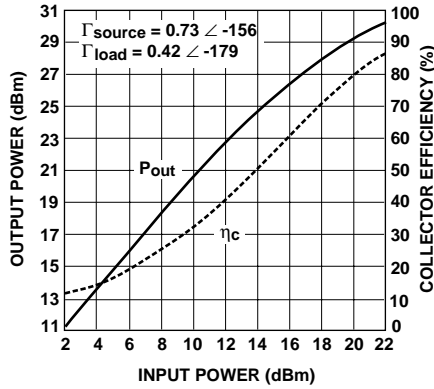

**Figure 1. Output Power and Collector Efficiency vs. Input Power.**

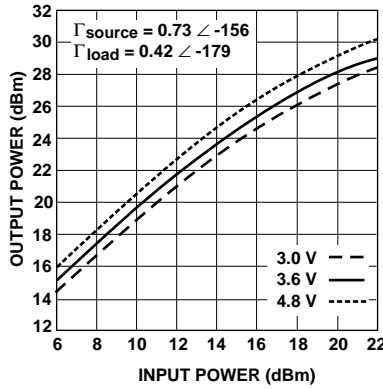

**Figure 2. Output Power vs. Input Power Over Bias Voltage.**

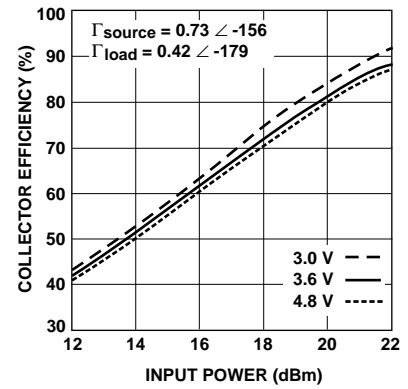

**Figure 3. Collector Efficiency vs. Input Power Over Bias Voltage.**

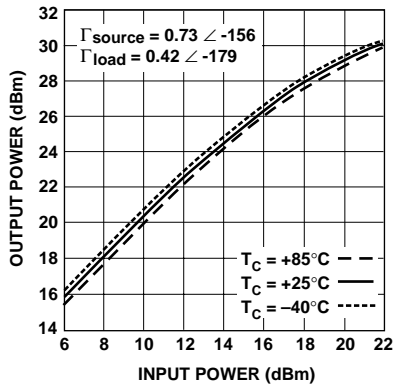

**Figure 4. Output Power vs. Input Power Over Temperature.**

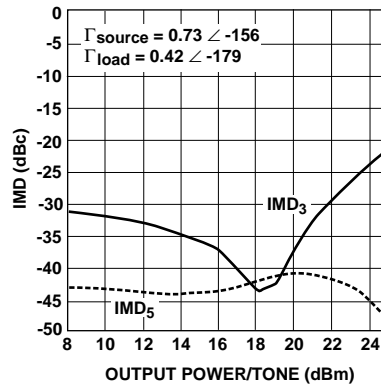

**Figure 5. IMD<sub>3</sub>, IMD<sub>5</sub> vs. Output Power Per Tone.**

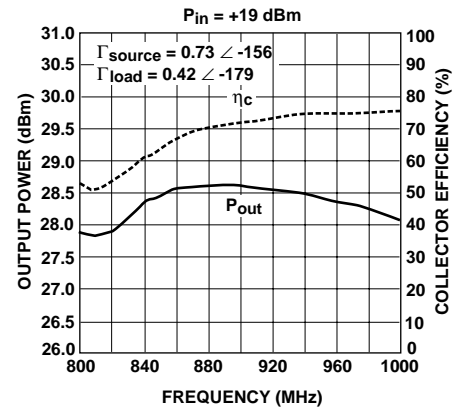

**Figure 6. Output Power and Collector Efficiency vs. Frequency.**  
Note: Tuned at 900 MHz, then Swept over Frequency.

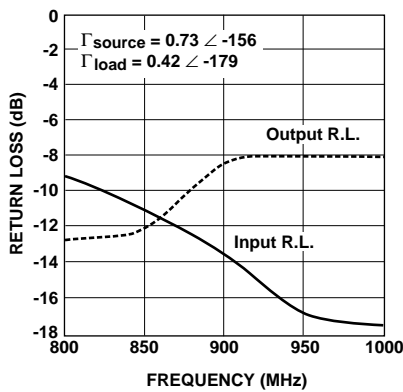

**Figure 7. Input and Output Return Loss vs. Frequency.**

## AT-31625 Typical Large Signal Impedances

$V_{CE} = 4.8\text{ V}$ ,  $I_{CQ} = 5\text{ mA}$ ,  $P_{out} = +28.0\text{ dBm}$

Freq. MHz	$\Gamma_{\text{source}}$		$\Gamma_{\text{load}}$	
	Mag.	Ang.	Mag.	Ang.
800	0.661	-149.0	0.382	-171.3
825	0.679	-150.6	0.394	-172.8
850	0.697	-152.4	0.403	-174.6
875	0.712	-154.2	0.412	-176.5
900	0.727	-155.8	0.422	-179.0
925	0.740	-157.5	0.426	179.3
950	0.754	-159.0	0.432	177.2
975	0.767	-160.4	0.437	174.9
1000	0.777	-162.1	0.438	172.5

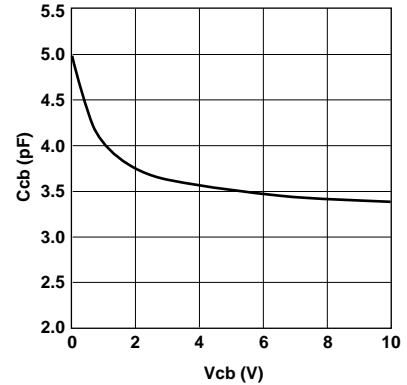
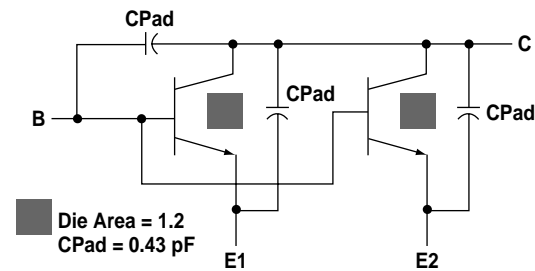

Figure 8. Collector-Base Capacitance vs. Collector-Base Voltage (DC Test).

## SPICE Model Parameters

### Die Model



Die Area = 1.2  
CPad = 0.43 pF

Label	Value	Label	Value
BF	150	TR	1E-9
IKF	299.9	EG	1.11
ISE	9.9E-11	IS	3.598E-15
NE	2.399	XTI	3
VAF	33.16	CJC	1.4E-12
NF	0.9935	VJC	0.4776
TF	1.6E-11	MJC	0.2508
XTF	0.006656	XCJC	0.001
VTF	0.02785	FC	0.999
ITF	0.001	CJE	5.06E-12
PTF	23	VJE	1.148
XTB	0	MJE	0.5965
BR	54.61	RB	0.752
IKR	81	IRB	0
ISC	8.7E-13	RBM	0.01
NC	1.587	RE	2.488
VAR	1.511	RC	1.288
NR	0.9886		

### Packaged Model

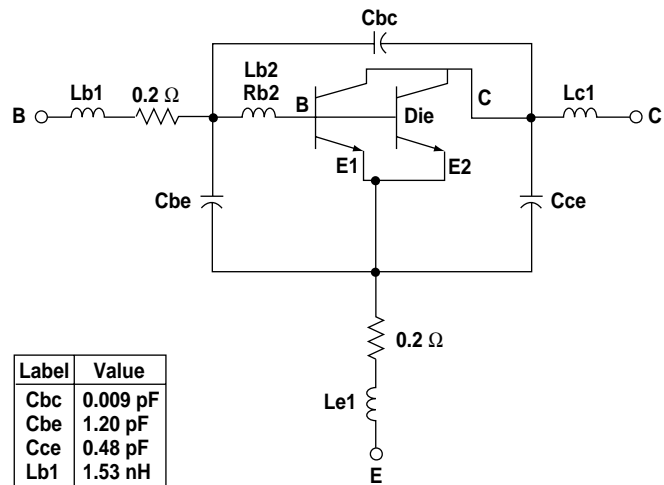

Label	Value
Cbc	0.009 pF
Cbe	1.20 pF
Cce	0.48 pF
Lb1	1.53 nH
Lb2	0.045 nH
Rb2	0.1 Ohm
Le1	0.38 nH
Lc1	0.47 nH

## AT-31625 Typical Scattering Parameters, Common Emitter, $Z_0 = 50 \Omega$

$V_{CE} = 3.0 \text{ V}, I_c = 200 \text{ mA}, T_c = 25^\circ\text{C}$

Freq. GHz	$S_{11}$		dB	$S_{21}$		dB	$S_{12}$		$S_{22}$	
	Mag.	Ang.		Mag.	Ang.		Mag.	Ang.	Mag.	Ang.
0.05	0.72	-150	30.7	34.19	113	-34.0	0.02	40	0.56	-120
0.10	0.77	-166	25.3	18.43	99	-34.0	0.02	42	0.52	-148
0.25	0.79	179	17.5	7.54	86	-28.0	0.04	57	0.51	-169
0.50	0.79	169	11.6	3.81	74	-23.1	0.07	64	0.51	-178
0.75	0.79	161	8.2	2.58	65	-20.9	0.09	63	0.52	177
0.90	0.79	156	6.7	2.17	59	-19.2	0.11	62	0.52	175
1.00	0.79	153	5.9	1.97	56	-18.4	0.12	61	0.52	174
1.25	0.79	146	4.1	1.61	48	-16.5	0.15	58	0.53	170
1.50	0.79	140	2.7	1.37	40	-14.9	0.18	54	0.54	167
1.75	0.79	133	1.7	1.21	32	-13.6	0.21	49	0.54	164
2.00	0.79	126	0.7	1.09	26	-12.8	0.23	45	0.55	160
2.25	0.79	120	0.0	1.00	19	-11.7	0.26	41	0.55	156
2.50	0.79	114	-0.6	0.93	13	-11.1	0.28	36	0.56	152

$V_{CE} = 3.6 \text{ V}, I_c = 200 \text{ mA}, T_c = 25^\circ\text{C}$

0.05	0.71	-148	31.2	36.39	114	-34.0	0.02	41	0.56	-117
0.10	0.76	-165	25.9	19.69	100	-34.0	0.02	43	0.51	-146
0.25	0.78	180	18.1	8.06	86	-28.0	0.04	57	0.50	-168
0.50	0.78	169	12.2	4.07	75	-24.4	0.06	64	0.50	-177
0.75	0.78	161	8.8	2.75	65	-20.9	0.09	64	0.51	178
0.90	0.78	156	7.3	2.31	60	-19.2	0.11	62	0.51	176
1.00	0.78	153	6.4	2.10	56	-18.4	0.12	61	0.51	174
1.25	0.78	146	4.7	1.71	48	-16.5	0.15	58	0.52	171
1.50	0.78	140	3.3	1.46	40	-14.9	0.18	54	0.53	168
1.75	0.78	133	2.1	1.28	33	-14.0	0.20	50	0.54	164
2.00	0.78	127	1.3	1.16	26	-12.8	0.23	46	0.54	161
2.25	0.78	121	0.4	1.05	19	-11.7	0.26	41	0.55	157
2.50	0.78	115	-0.2	0.98	13	-11.1	0.28	37	0.55	153

$V_{CE} = 4.8 \text{ V}, I_c = 200 \text{ mA}, T_c = 25^\circ\text{C}$

0.05	0.70	-145	31.7	38.47	115	-34.0	0.02	41	0.56	-114
0.10	0.75	-164	26.4	20.90	100	-34.0	0.02	43	0.50	-144
0.25	0.77	-180	18.7	8.57	87	-28.0	0.04	57	0.49	-167
0.50	0.77	169	12.7	4.33	75	-24.4	0.06	64	0.49	-176
0.75	0.77	161	9.3	2.92	66	-20.9	0.09	64	0.49	179
0.90	0.77	157	7.8	2.45	60	-19.2	0.11	62	0.50	176
1.00	0.77	154	7.0	2.23	57	-18.4	0.12	61	0.50	175
1.25	0.77	147	5.2	1.81	48	-16.5	0.15	58	0.51	172
1.50	0.77	140	3.8	1.54	41	-14.9	0.18	54	0.51	168
1.75	0.77	134	2.6	1.35	33	-14.0	0.20	50	0.52	165
2.00	0.77	127	1.7	1.22	27	-12.8	0.23	46	0.53	162
2.25	0.77	121	0.9	1.11	20	-12.0	0.25	41	0.54	158
2.50	0.77	115	0.3	1.03	13	-11.1	0.28	37	0.54	154

### Typical Performance

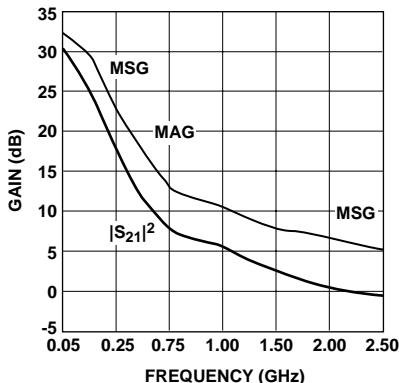

Figure 9. Insertion Power Gain, Maximum Available Gain, and Maximum Stable Gain vs. Frequency.  $V_{CE} = 3.0\text{V}$ ,  $I_c = 200 \text{ mA}$ .

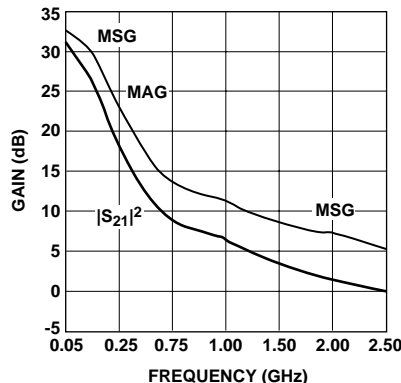

Figure 10. Insertion Power Gain, Maximum Available Gain, and Maximum Stable Gain vs. Frequency.  $V_{CE} = 3.6\text{V}$ ,  $I_c = 200 \text{ mA}$ .

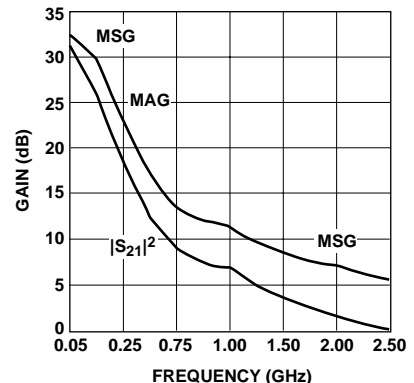

Figure 11. Insertion Power Gain, Maximum Available Gain, and Maximum Stable Gain vs. Frequency.  $V_{CE} = 4.8\text{V}$ ,  $I_c = 200 \text{ mA}$ .

### AT-31625 Typical Performance, $T_C = 25^\circ\text{C}$

Frequency = 1800 MHz,  $V_{CE} = 4.8\text{ V}$ ,  $I_{CQ} = 15\text{ mA}$ , CW operation, Test Circuit B, unless otherwise specified.

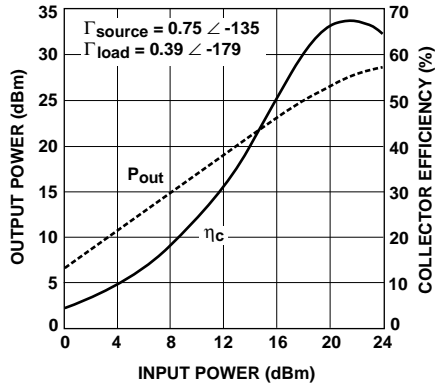

Figure 12. Output Power and Collector Efficiency vs. Input Power.

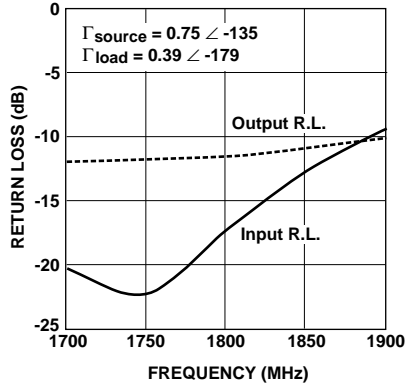

Figure 13. Input and Output Return Loss vs. Frequency.

### AT-31625 Typical Large Signal Impedances

$V_{CE} = 4.8\text{ V}$ ,  $I_{CQ} = 15\text{ mA}$ ,  $P_{out} = +25.0\text{ dBm}$

Freq. MHz	$\Gamma_{\text{source}}$		$\Gamma_{\text{load}}$	
	Mag.	Ang.	Mag.	Ang.
1700	0.717	-131.8	0.373	-174.3
1725	0.724	-132.6	0.378	-175.6
1750	0.732	-133.4	0.381	-176.7
1775	0.743	-134.3	0.386	-177.9
1800	0.752	-135.4	0.390	-179.1
1825	0.763	-136.3	0.394	179.5
1850	0.773	-137.0	0.397	178.4
1875	0.780	-137.8	0.401	177.1
1900	0.788	-138.7	0.403	175.7

### Test Circuit A: Test Circuit Board Layout @ 900 MHz

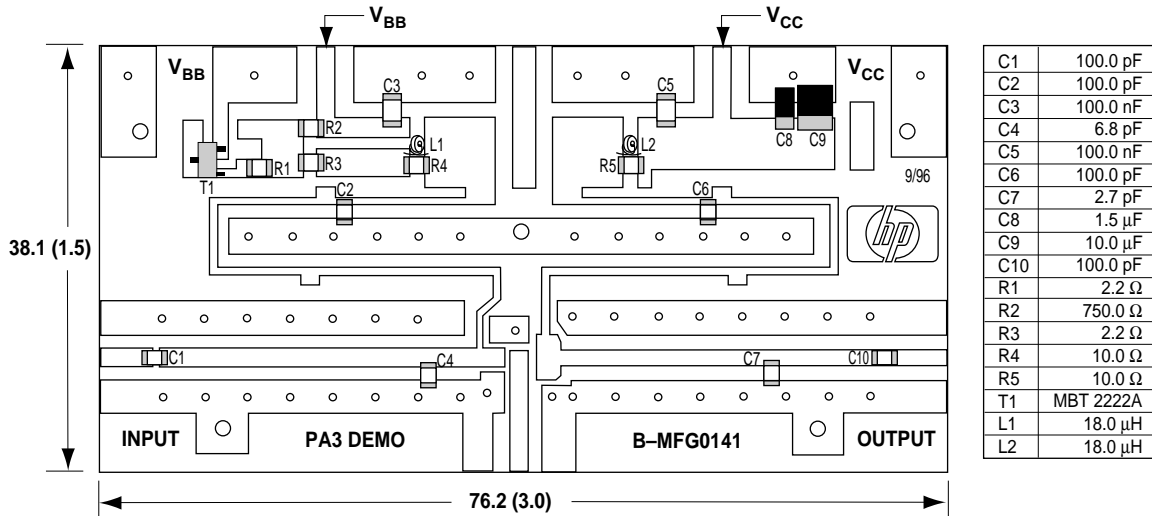

**CW Test**  
 $V_{CE} = 4.8 \text{ V}$   
 $I_{CQ} = 5.0 \text{ mA}$   
 Freq. = 900 MHz

**Test Circuit:**  
 FR-4 Microstrip, glass epoxy board  
 Dielectric Constant = 4.5  
 Thickness = 0.79 (.031)

**NOTE:**  
 Dimensions are shown in millimeters (inches).

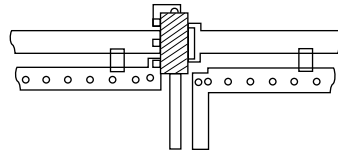

### Test Circuit A: Test Circuit Schematic Diagram @ 900 MHz

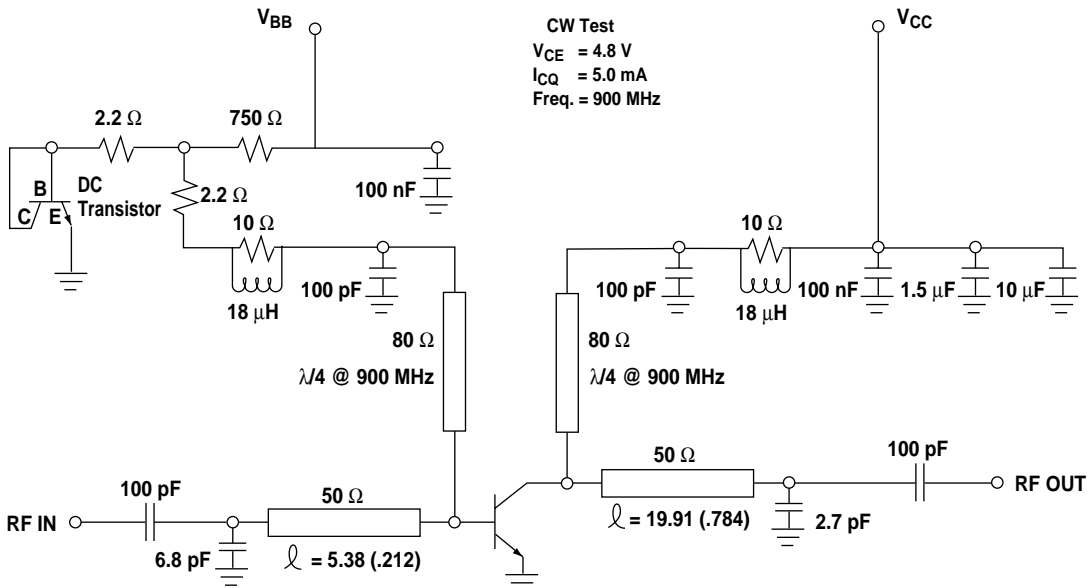

### Test Circuit B: Test Circuit Board Layout @ 1800 MHz

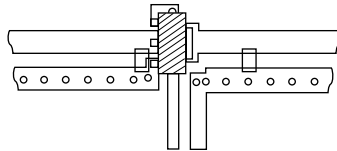
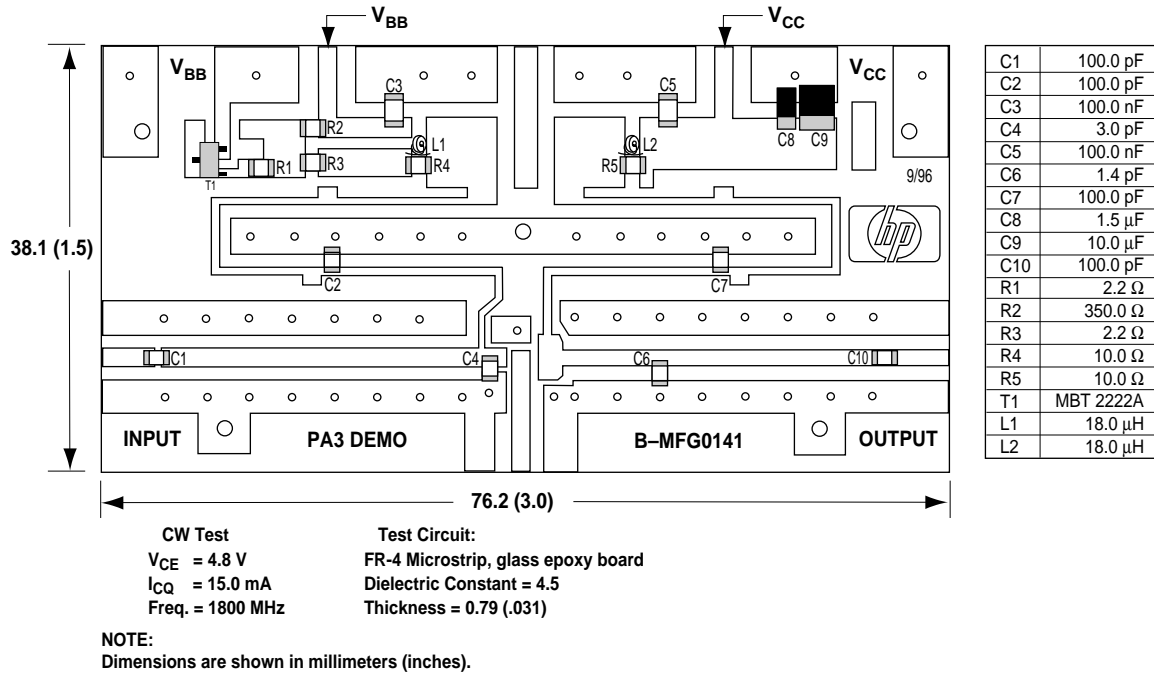

### Test Circuit B: Test Circuit Schematic Diagram @ 1800 MHz

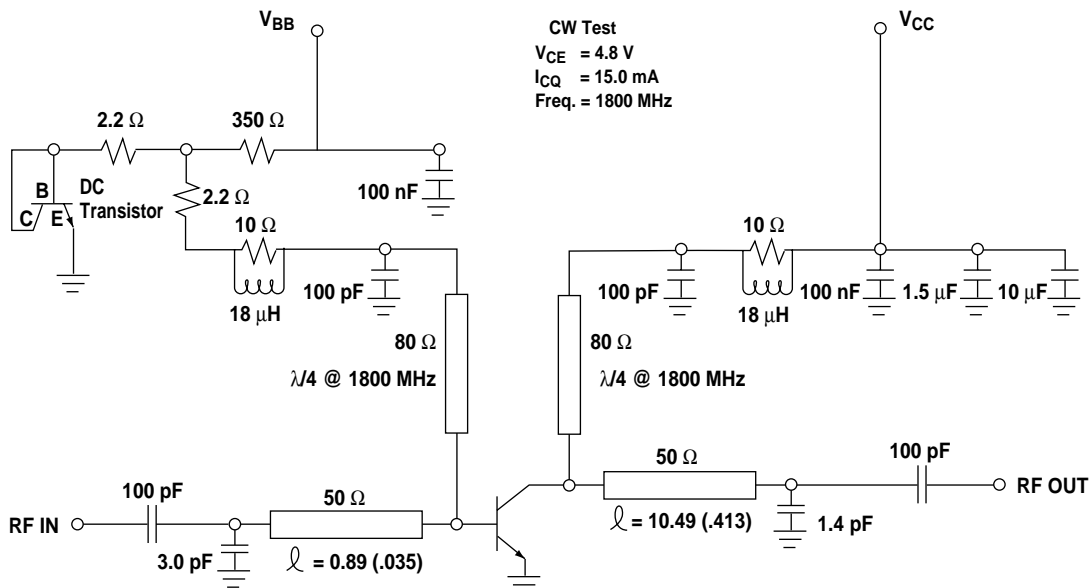



## Part Number Ordering Information

Part Number	No. of Devices	Container
AT-31625-TR1	1000	7" Reel
AT-31625-BLK	25	Carrier Tape

## Package Dimensions

### MSOP-3 Surface Mount Plastic Package

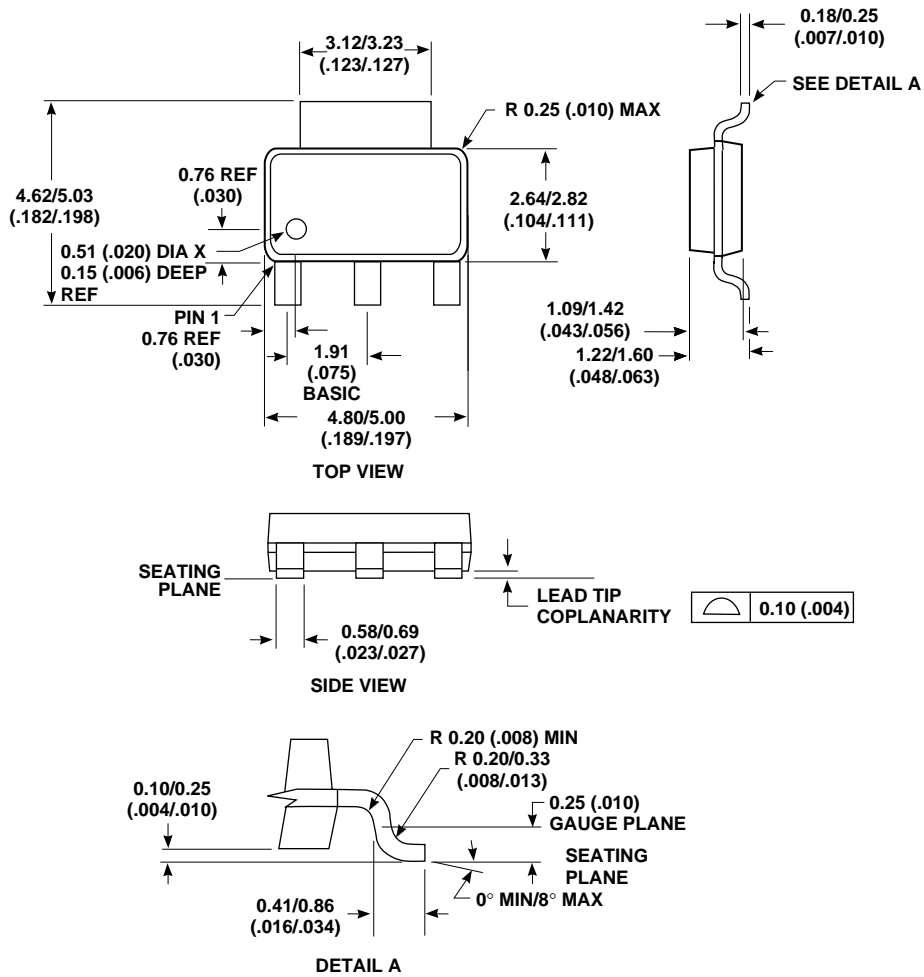

NOTE:  
DIMENSIONS ARE SHOWN IN MILLIMETERS (INCHES)

## Tape Dimensions and Product Orientation for Package MSOP-3

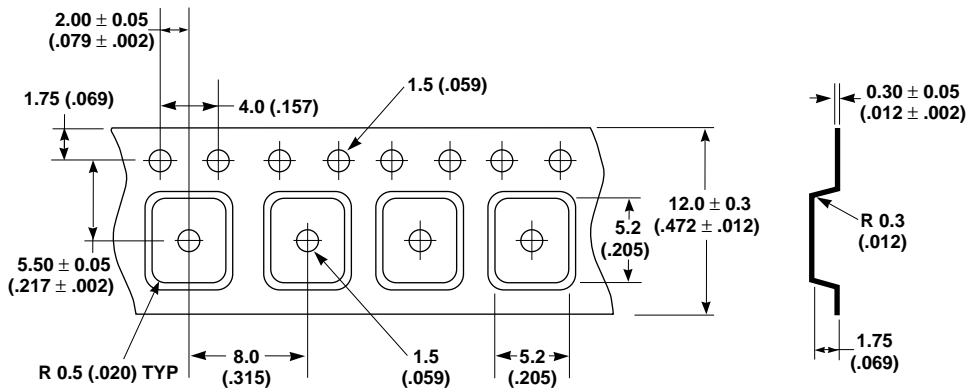
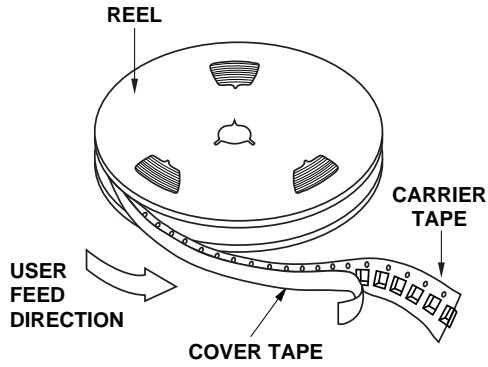

- NOTES:  
 1. DIMENSIONS ARE SHOWN IN MILLIMETERS (INCHES)  
 2. TOLERANCES: .X  $\pm$  0.1 (.XXX  $\pm$  .004)