

# Cascadable Silicon Bipolar MMIC Amplifier

## Technical Data

### MSA-1023

#### Features

- **High Output Power:**  
+27 dBm Typical  $P_{1\text{dB}}$  at 1.0 GHz
- **Low Distortion:**  
37 dBm Typical  $IP_3$  at 1.0 GHz
- **8.5 dB Typical Gain at 1.0 GHz**
- **Hermetic, Metal/Beryllia Stripline Package**
- **Impedance Matched to 25  $\Omega$  for Push-Pull Configurations**

#### Description

The MSA-1023 is a high performance, medium power silicon bipolar Monolithic Microwave Integrated Circuit (MMIC) housed in a hermetic, BeO flange package for good thermal characteristics.

This MMIC is designed for use in a push-pull configuration in a 25  $\Omega$  system. The MSA-1023 can also be used as a single-ended amplifier in a 50  $\Omega$  system with slightly reduced performance. Typical applications include narrow and broadband RF amplifiers in industrial and military systems.

The MSA-series is fabricated using HP's 10 GHz  $f_T$ , 25 GHz  $f_{\text{MAX}}$ , silicon bipolar MMIC process which uses nitride self-alignment, ion implantation, and gold metallization to achieve excellent performance, uniformity and reliability. The use of an external bias resistor for temperature and current stability also allows bias flexibility.

#### 230 mil BeO Flange Package

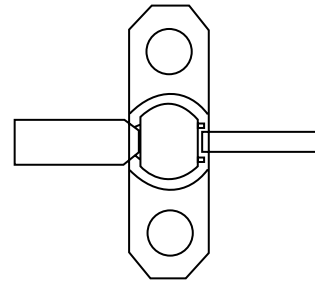

#### Typical Push-Pull Biasing Configuration

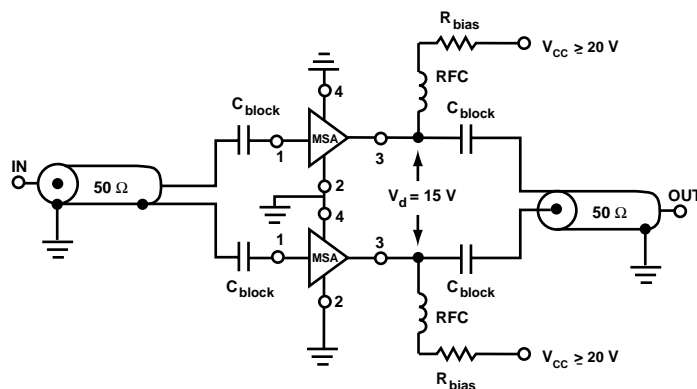

## MSA-1023 Absolute Maximum Ratings

Parameter	Absolute Maximum <sup>[1]</sup>
Device Current	425 mA
Power Dissipation <sup>[2,3]</sup>	7.0 W
RF Input Power	+25 dBm
Junction Temperature	200°C
Storage Temperature	-65 to 200°C

**Thermal Resistance<sup>[2,4]</sup>:**

$$\theta_{jc} = 15^{\circ}\text{C/W}$$

### Notes:

1. Permanent damage may occur if any of these limits are exceeded.
2.  $T_{\text{CASE}} = 25^{\circ}\text{C}$ .
3. Derate at  $66.7 \text{ mW}/^{\circ}\text{C}$  for  $T_{\text{C}} > 95^{\circ}\text{C}$ .
4. The small spot size of this technique results in a higher, though more accurate determination of  $\theta_{jc}$  than do alternate methods. See MEASUREMENTS section "Thermal Resistance" for more information.

## Electrical Specifications<sup>[1]</sup>, $T_{\text{A}} = 25^{\circ}\text{C}$

Symbol	Parameters and Test Conditions: $I_{\text{a}} = 325 \text{ mA}$ , $Z_{\text{o}} = 25 \Omega$	Units	Min.	Typ.	Max.
$G_{\text{P}}$	Power Gain ( $ S_{21} ^2$ ) $f = 1.0 \text{ GHz}$	dB	7.5	8.5	9.5
$\Delta G_{\text{P}}$	Gain Flatness $f = 0.1 \text{ to } 2.0 \text{ GHz}$	dB		$\pm 0.6$	
$f_{3 \text{ dB}}$	3 dB Bandwidth <sup>[2]</sup>	GHz		2.5	
VSWR	Input VSWR $f = 0.1 \text{ to } 2.0 \text{ GHz}$			2.0:1	
	Output VSWR $f = 0.1 \text{ to } 2.0 \text{ GHz}$			2.8:1	
NF	25 $\Omega$ Noise Figure $f = 1.0 \text{ GHz}$	dB		7.0	
$P_{1 \text{ dB}}$	Output Power at 1 dB Gain Compression $f = 1.0 \text{ GHz}$	dBm	25.0	27.0	
$\text{IP}_3$	Third Order Intercept Point $f = 1.0 \text{ GHz}$	dBm		37.0	
$t_{\text{D}}$	Group Delay $f = 1.0 \text{ GHz}$	psec		250	
$V_{\text{d}}$	Device Voltage	V	13.5	15.0	16.5
$\text{dV}/\text{dT}$	Device Voltage Temperature Coefficient	$\text{mV}/^{\circ}\text{C}$		-18.0	

### Notes:

1. The recommended operating current range for this device is 150 to 400 mA. Typical performance as a function of current is on the following page.
2. Referenced from 10 MHz gain ( $G_{\text{P}}$ ).

### MSA-1023 Typical Scattering Parameters ( $Z_0 = 50 \Omega$ , $T_A = 25^\circ\text{C}$ , $I_d = 325 \text{ mA}$ )

Freq. GHz	$S_{11}$		$S_{21}$			$S_{12}$			$S_{22}$		k
	Mag	Ang	dB	Mag	Ang	dB	Mag	Ang	Mag	Ang	
0.001	.40	-121	15.3	5.85	149	-17.9	.128	22	.42	-99	0.69
0.005	.51	-167	8.5	2.67	156	-15.9	.160	6	.45	-161	1.05
0.010	.52	-174	7.5	2.36	166	-15.8	.162	3	.45	-171	1.16
0.025	.52	-178	7.2	2.28	172	-15.8	.162	1	.45	-177	1.20
0.050	.52	179	7.1	2.26	173	-15.8	.161	-1	.45	-179	1.21
0.100	.53	176	7.0	2.25	170	-15.8	.161	-3	.45	179	1.21
0.200	.53	172	7.0	2.25	163	-15.8	.161	-5	.46	174	1.21
0.400	.51	164	7.0	2.24	146	-15.8	.161	-11	.46	170	1.22
0.600	.48	157	7.0	2.24	130	-16.0	.159	-16	.45	165	1.23
0.800	.45	151	7.0	2.23	113	-16.1	.157	-21	.44	161	1.24
1.000	.42	146	7.0	2.23	95	-16.2	.155	-26	.44	157	1.24
1.200	.38	144	6.9	2.22	78	-16.4	.151	-31	.44	155	1.24
1.400	.35	145	6.8	2.20	61	-16.7	.146	-36	.45	154	1.24
1.600	.34	149	6.6	2.15	44	-17.0	.141	-41	.46	153	1.22
1.800	.36	152	6.3	2.07	19	-17.3	.136	-45	.49	150	1.18
2.000	.39	153	5.9	1.97	11	-17.7	.130	-49	.62	148	1.13
2.500	.51	148	4.6	1.69	-24	-18.3	.121	-52	.52	140	.91
3.000	.60	133	3.0	1.41	-57	-17.9	.127	-57	.70	128	.59

A model for this device is available in the DEVICE MODELS section.

### Typical Performance, $T_A = 25^\circ\text{C}$

(unless otherwise noted)

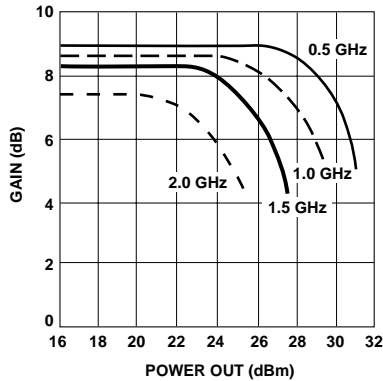

Figure 1. Typical Gain vs. Power Out,  $Z_0 = 25 \Omega$ ,  $I_d = 325 \text{ mA}$ .

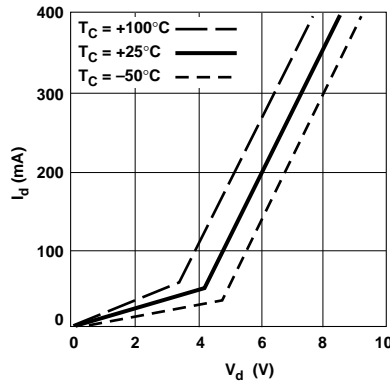

Figure 2. Device Current vs. Voltage.

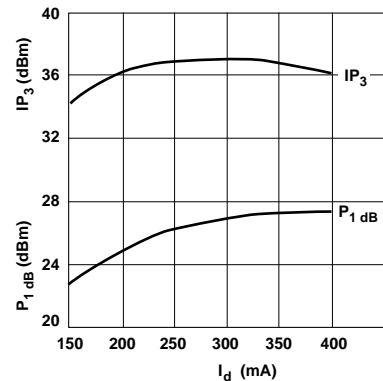

Figure 3. Output Power at 1 dB Gain Compression, Third Order Intercept Point vs. Current,  $Z_0 = 25 \Omega$ ,  $f = 1.0 \text{ GHz}$ .

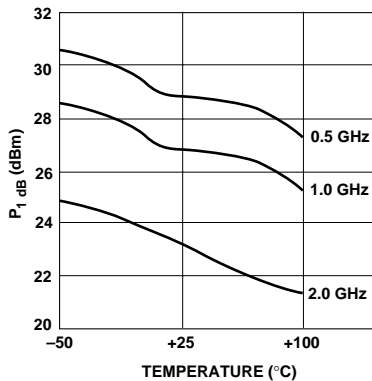

Figure 4. Output Power at 1 dB Gain Compression vs. Temperature,  $Z_0 = 25 \Omega$ ,  $I_d = 325 \text{ mA}$ .

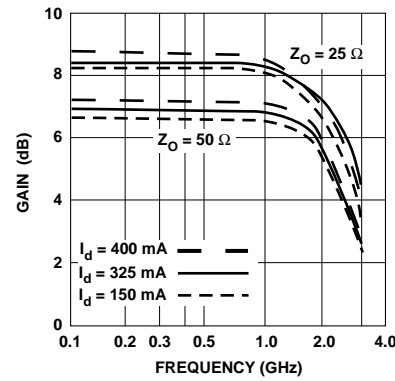

Figure 5. Gain vs. Frequency,  $I_d = 325 \text{ mA}$ .

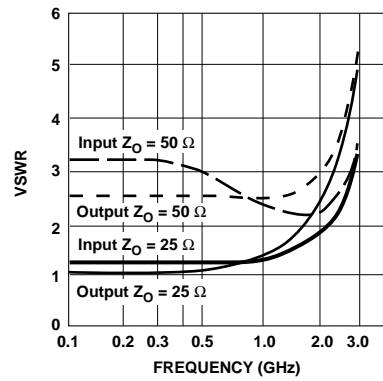

Figure 6. VSWR vs. Frequency,  $I_d = 325 \text{ mA}$ .

## 230 mil BeO Flange Package

