

Cascadable Silicon Bipolar MMIC Amplifier

Technical Data

MSA-0786

Features

- **Cascadable 50 Ω Gain Block**
- **Low Operating Voltage:**
4.0 V Typical V_d
- **3 dB Bandwidth:**
DC to 2.0 GHz
- **12.5 dB Typical Gain at
1.0 GHz**
- **Unconditionally Stable
($k > 1$)**
- **Surface Mount Plastic
Package**
- **Tape-and-Reel Packaging
Option Available^[1]**

Note:

1. Refer to PACKAGING section "Tape-and-Reel Packaging for Semiconductor Devices."

Description

The MSA-0786 is a high performance silicon bipolar Monolithic Microwave Integrated Circuit (MMIC) housed in a low cost, surface mount plastic package. This MMIC is designed for use as a general purpose 50 Ω gain block. Applications include narrow and broad band IF and RF amplifiers in commercial and industrial applications.

The MSA-series is fabricated using HP's 10 GHz f_T , 25 GHz f_{MAX} , silicon bipolar MMIC process which uses nitride self-alignment, ion implantation, and gold metalli-

86 Plastic Package

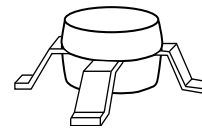

zation to achieve excellent performance, uniformity and reliability. The use of an external bias resistor for temperature and current stability also allows bias flexibility.

Typical Biasing Configuration

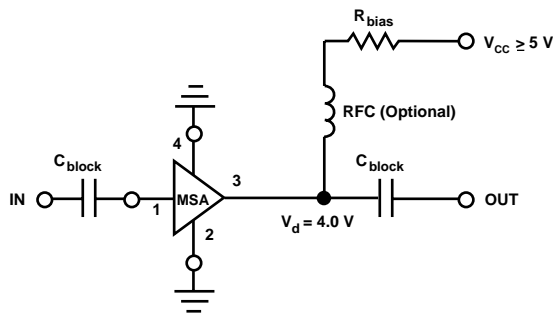

MSA-0786 Absolute Maximum Ratings

Parameter	Absolute Maximum ^[1]
Device Current	60 mA
Power Dissipation ^[2,3]	275 mW
RF Input Power	+13 dBm
Junction Temperature	150°C
Storage Temperature	-65 to 150°C

Thermal Resistance^[2,4]:

$$\theta_{jc} = 120^{\circ}\text{C/W}$$

Notes:

1. Permanent damage may occur if any of these limits are exceeded.
2. $T_{\text{CASE}} = 25^{\circ}\text{C}$.
3. Derate at $8.3 \text{ mW}/^{\circ}\text{C}$ for $T_{\text{C}} > 117^{\circ}\text{C}$.
4. See MEASUREMENTS section "Thermal Resistance" for more information.

Electrical Specifications^[1], $T_{\text{A}} = 25^{\circ}\text{C}$

Symbol	Parameters and Test Conditions: $I_{\text{d}} = 22 \text{ mA}$, $Z_{\text{o}} = 50 \Omega$	Units	Min.	Typ.	Max.
G_{P}	Power Gain ($ S_{21} ^2$) $f = 0.1 \text{ GHz}$ $f = 1.0 \text{ GHz}$	dB	10.5	13.5 12.5	
ΔG_{P}	Gain Flatness $f = 0.1 \text{ to } 1.3 \text{ GHz}$	dB		± 0.7	
$f_{3 \text{ dB}}$	3 dB Bandwidth	GHz		2.0	
VSWR	Input VSWR $f = 0.1 \text{ to } 2.5 \text{ GHz}$			1.7:1	
	Output VSWR $f = 0.1 \text{ to } 2.5 \text{ GHz}$			1.7:1	
NF	50 Ω Noise Figure $f = 1.0 \text{ GHz}$	dB		5.0	
$P_{1 \text{ dB}}$	Output Power at 1 dB Gain Compression $f = 1.0 \text{ GHz}$	dBm		5.5	
IP_3	Third Order Intercept Point $f = 1.0 \text{ GHz}$	dBm		19.0	
t_{D}	Group Delay $f = 1.0 \text{ GHz}$	psec		150	
V_{d}	Device Voltage	V	3.2	4.0	4.8
dV/dT	Device Voltage Temperature Coefficient	$\text{mV}/^{\circ}\text{C}$		-7.0	

Note:

1. The recommended operating current range for this device is 15 to 40 mA. Typical performance as a function of current is on the following page.

Part Number Ordering Information

Part Number	No. of Devices	Container
MSA-0786-TR1	1000	7" Reel
MSA-0786-BLK	100	Antistatic Bag

For more information, see "Tape and Reel Packaging for Semiconductor Devices".

MSA-0786 Typical Scattering Parameters ($Z_0 = 50 \Omega$, $T_A = 25^\circ\text{C}$, $I_d = 22 \text{ mA}$)

Freq. GHz	S_{11}		S_{21}			S_{12}			S_{22}	
	Mag	Ang	dB	Mag	Ang	dB	Mag	Ang	Mag	Ang
0.1	.05	175	13.5	4.74	174	-18.7	.116	1	.14	-12
0.2	.05	174	13.4	4.71	169	-18.7	.117	3	.14	-22
0.4	.04	167	13.3	4.64	158	-18.4	.120	4	.15	-44
0.6	.04	175	13.1	4.52	148	-18.3	.122	7	.16	-65
0.8	.05	-156	12.9	4.39	138	-18.0	.126	8	.17	-84
1.0	.06	-134	12.6	4.25	127	-17.5	.134	10	.18	-102
1.5	.08	-142	11.6	3.79	103	-16.6	.148	9	.21	-139
2.0	.15	-159	10.5	3.34	80	-15.7	.164	7	.23	-164
2.5	.25	-176	9.2	2.89	63	-15.1	.176	5	.24	174
3.0	.33	166	7.8	2.45	44	-14.7	.185	1	.24	159
3.5	.41	150	6.5	2.11	27	-14.9	.179	-5	.24	149
4.0	.49	137	5.2	1.82	12	-15.1	.177	-9	.23	145
5.0	.60	116	3.0	1.41	-14	-15.4	.169	-14	.26	145

Note:

1. A model for this device is available in the DEVICE MODELS section.

Typical Performance, $T_A = 25^\circ\text{C}$

(unless otherwise noted)

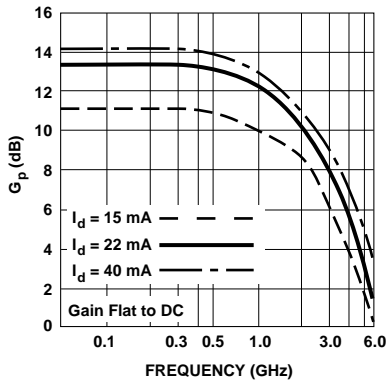

Figure 1. Typical Power Gain vs. Frequency.

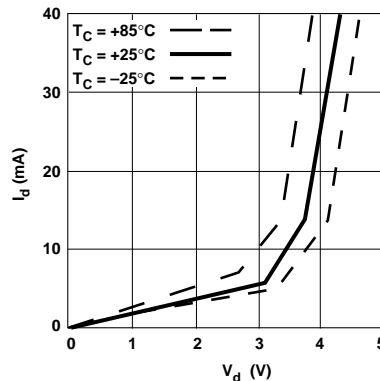

Figure 2. Device Current vs. Voltage.

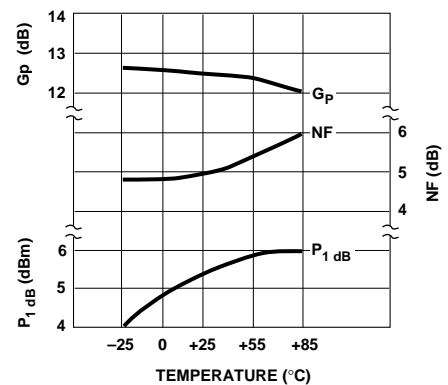

Figure 3. Output Power at 1 dB Gain Compression, NF and Power Gain vs. Case Temperature, $f = 1.0 \text{ GHz}$, $I_d = 22 \text{ mA}$.

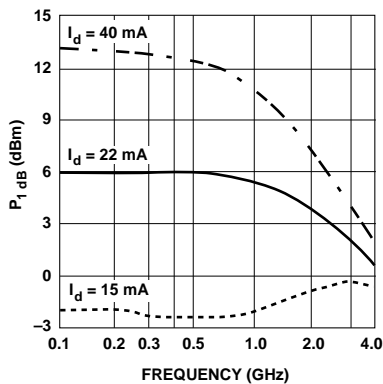

Figure 4. Output Power at 1 dB Gain Compression vs. Frequency.

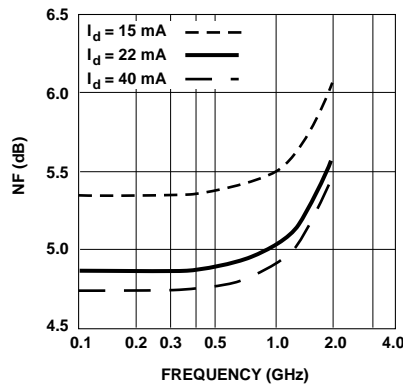
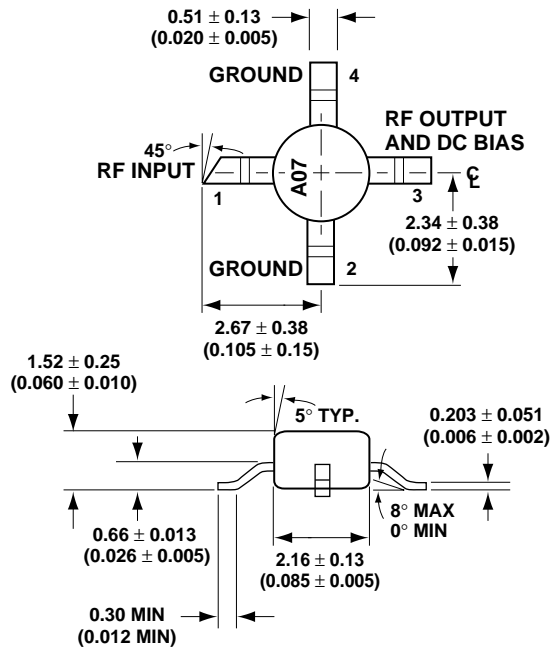

Figure 5. Noise Figure vs. Frequency.

86 Plastic Package Dimensions



DIMENSIONS ARE IN MILLIMETERS (INCHES)

www.hp.com/go/rf

For technical assistance or the location of your nearest Hewlett-Packard sales office, distributor or representative call:

Americas/Canada: 1-800-235-0312 or 408-654-8675

Far East/Australasia: Call your local HP sales office.

Japan: (81 3) 3335-8152

Europe: Call your local HP sales office.

Data subject to change.
Copyright © 1999 Hewlett-Packard Co.

Obsoletes 5965-9594E

5968-4716E (3/99)