

Cascadable Silicon Bipolar MMIC Amplifier

Technical Data

MSA-0286

Features

- **Cascadable 50 Ω Gain Block**
- **3 dB Bandwidth:**
DC to 2.5 GHz
- **12.0 dB Typical Gain at 1.0 GHz**
- **Unconditionally Stable (k>1)**
- **Surface Mount Plastic Package**
- **Tape-and-Reel Packaging Option Available^[1]**

Note:

1. Refer to PACKAGING section "Tape-and-Reel Packaging for Surface Mount Semiconductors".

Description

The MSA-0286 is a high performance silicon bipolar Monolithic Microwave Integrated Circuit (MMIC) housed in a low cost, surface mount plastic package. This MMIC is designed for use as a general purpose 50 Ω gain block. Typical applications include narrow and broad band IF and RF amplifiers in commercial and industrial applications.

The MSA-series is fabricated using HP's 10 GHz f_T , 25 GHz f_{MAX} , silicon bipolar MMIC process which uses nitride self-alignment,

86 Plastic Package

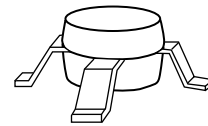

ion implantation, and gold metallization to achieve excellent performance, uniformity and reliability. The use of an external bias resistor for temperature and current stability also allows bias flexibility.

Typical Biasing Configuration

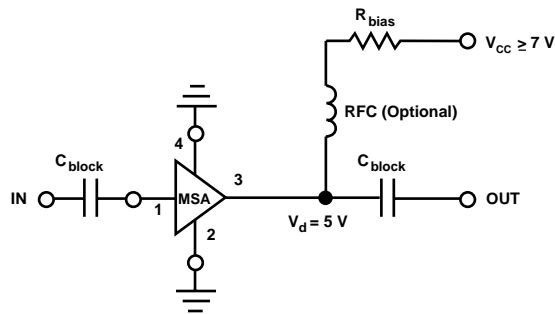

MSA-0286 Absolute Maximum Ratings

Parameter	Absolute Maximum ^[1]
Device Current	60 mA
Power Dissipation ^[2,3]	325 mW
RF Input Power	+13 dBm
Junction Temperature	150°C
Storage Temperature	-65 to 150°C

Thermal Resistance^{[2,4]:}

$$\theta_{jc} = 105^{\circ}\text{C/W}$$

Notes:

1. Permanent damage may occur if any of these limits are exceeded.
2. $T_{\text{CASE}} = 25^{\circ}\text{C}$.
3. Derate at 9.5 mW/°C for $T_{\text{C}} > 116^{\circ}\text{C}$.
4. See MEASUREMENTS section "Thermal Resistance" for more information.

Electrical Specifications^[1], $T_{\text{A}} = 25^{\circ}\text{C}$

Symbol	Parameters and Test Conditions: $I_{\text{d}} = 25 \text{ mA}$, $Z_{\text{O}} = 50 \Omega$	Units	Min.	Typ.	Max.
G_{P}	Power Gain ($ S_{21} ^2$) f = 0.1 GHz f = 1.0 GHz	dB	10.0	12.5 12.0	
ΔG_{P}	Gain Flatness f = 0.1 to 1.6 GHz	dB		± 0.6	
$f_{3 \text{ dB}}$	3 dB Bandwidth	GHz		2.5	
VSWR	Input VSWR f = 0.1 to 3.0 GHz			1.5:1	
	Output VSWR f = 0.1 to 3.0 GHz			1.4:1	
NF	50 Ω Noise Figure f = 1.0 GHz	dB		6.5	
$P_{1 \text{ dB}}$	Output Power at 1 dB Gain Compression f = 1.0 GHz	dBm		4.5	
IP_3	Third Order Intercept Point f = 1.0 GHz	dBm		17.0	
t_{D}	Group Delay f = 1.0 GHz	psec		140	
V_{d}	Device Voltage	V	4.0	5.0	6.0
dV/dT	Device Voltage Temperature Coefficient	mV/°C		-8.0	

Note:

1. The recommended operating current range for this device is 18 to 40 mA. Typical performance as a function of current is on the following page.

Part Number Ordering Information

Part Number	No. of Devices	Container
MSA-0286-TR1	1000	7" Reel
MSA-0286-BLK	100	Antistatic Bag

For more information, see "Tape and Reel Packaging for Semiconductor Devices".

MSA-0286 Typical Scattering Parameters ($Z_0 = 50 \Omega$, $T_A = 25^\circ\text{C}$, $I_d = 25 \text{ mA}$)

Freq. GHz	S_{11}		S_{21}			S_{12}			S_{22}	
	Mag	Ang	dB	Mag	Ang	dB	Mag	Ang	Mag	Ang
0.1	.10	171	12.5	4.22	175	-18.5	.119	1	.16	-5
0.2	.10	161	12.5	4.20	170	-18.3	.121	3	.16	-11
0.4	.10	144	12.4	4.16	159	-18.2	.122	6	.15	-24
0.6	.09	129	12.2	4.09	149	-18.0	.126	6	.15	-36
0.8	.08	119	12.1	4.01	139	-18.0	.127	9	.14	-48
1.0	.08	108	11.9	3.91	129	-17.4	.135	8	.14	-62
1.5	.06	111	11.3	3.67	106	-16.5	.149	12	.11	-99
2.0	.08	141	10.5	3.35	84	-15.7	.164	11	.11	-141
2.5	.14	150	9.6	3.01	67	-14.8	.182	9	.12	-176
3.0	.21	142	8.6	2.68	48	-14.3	.194	5	.13	155
3.5	.29	132	7.5	2.37	30	-14.0	.200	1	.14	140
4.0	.36	121	6.4	2.09	15	-13.5	.211	-3	.16	134
5.0	.50	101	4.1	1.61	-12	-13.3	.216	-12	.20	132

A model for this device is available in the DEVICE MODELS section.

Typical Performance, $T_A = 25^\circ\text{C}$

(unless otherwise noted)

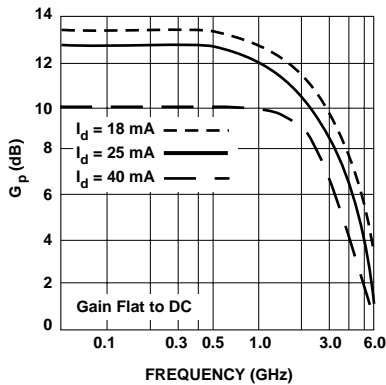

Figure 1. Typical Power Gain vs. Frequency.

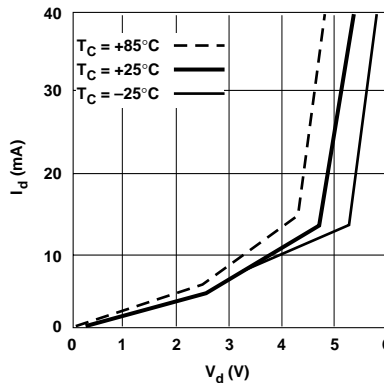

Figure 2. Device Current vs. Voltage.

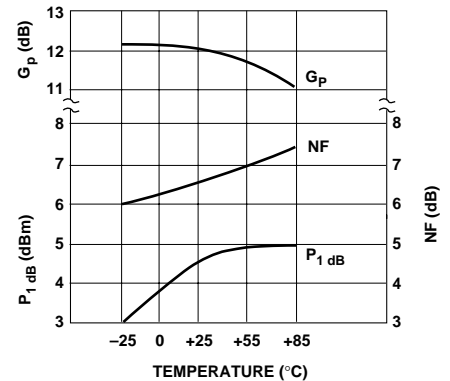

Figure 3. Output Power at 1 dB Gain Compression, NF and Power Gain vs. Case Temperature, $f = 1.0 \text{ GHz}$, $I_d = 25 \text{ mA}$.

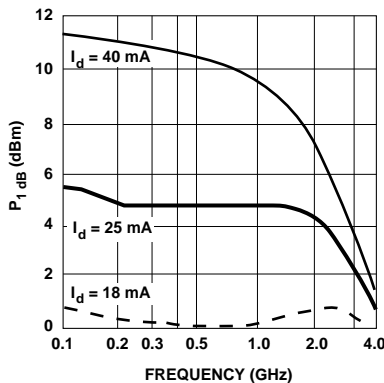

Figure 4. Output Power at 1 dB Gain Compression vs. Frequency.

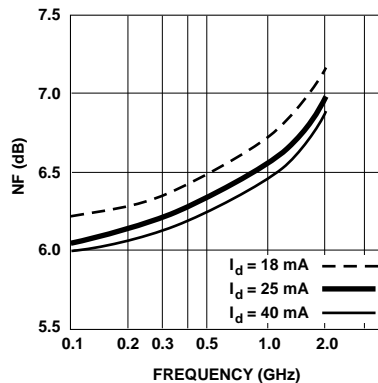
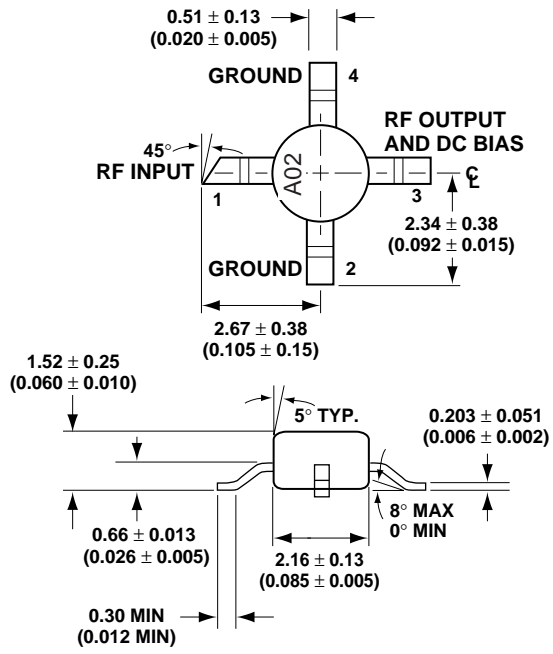

Figure 5. Noise Figure vs. Frequency.

86 Plastic Package Dimensions



DIMENSIONS ARE IN MILLIMETERS (INCHES)