

Cascadable Silicon Bipolar MMIC Amplifier

Technical Data

MSA-0270

Features

- **Cascadable 50 Ω Gain Block**
- **3 dB Bandwidth:**
DC to 2.8 GHz
- **12.0 dB Typical Gain at 1.0 GHz**
- **Unconditionally Stable (k>1)**
- **Hermetic Gold-ceramic Microstrip Package**

Description

The MSA-0270 is a high performance silicon bipolar Monolithic Microwave Integrated Circuit (MMIC) housed in a hermetic, high reliability package. This

MMIC is designed for use as a general purpose 50 Ω gain block. Typical applications include narrow and broad band IF and RF amplifiers in industrial and military applications.

The MSA-series is fabricated using HP's 10 GHz f_T , 25 GHz f_{MAX} silicon bipolar MMIC process which uses nitride self-alignment, ion implantation, and gold metallization to achieve excellent performance, uniformity and reliability. The use of an external bias resistor for temperature and current stability also allows bias flexibility.

70 mil Package

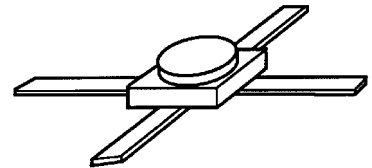

Typical Biasing Configuration

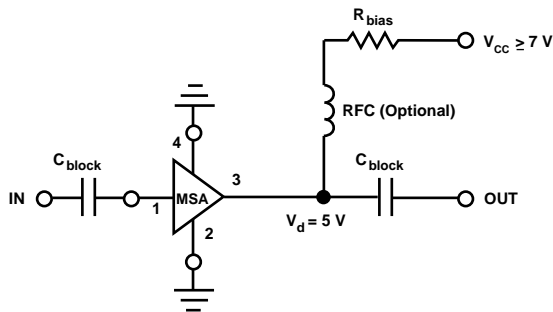

MSA-0270 Absolute Maximum Ratings

Parameter	Absolute Maximum ^[1]
Device Current	60 mA
Power Dissipation ^[2,3]	325 mW
RF Input Power	+13 dBm
Junction Temperature	200°C
Storage Temperature	-65 to 200°C

Thermal Resistance^[2,4]:
 $\theta_{jc} = 120^{\circ}\text{C}/\text{W}$

Notes:

1. Permanent damage may occur if any of these limits are exceeded.
2. $T_{\text{CASE}} = 25^{\circ}\text{C}$.
3. Derate at 8.3 mW/°C for $T_{\text{C}} > 161^{\circ}\text{C}$.
4. The small spot size of this technique results in a higher, though more accurate determination of θ_{jc} than do alternate methods. See MEASUREMENTS section "Thermal Resistance" for more information.

Electrical Specifications^[1], $T_{\text{A}} = 25^{\circ}\text{C}$

Symbol	Parameters and Test Conditions: $I_{\text{d}} = 25 \text{ mA}$, $Z_{\text{O}} = 50 \Omega$	Units	Min.	Typ.	Max.
G_{P}	Power Gain ($ S_{21} ^2$) $f = 0.1 \text{ GHz}$	dB	11.5	12.5	13.5
ΔG_{P}	Gain Flatness $f = 0.1 \text{ to } 1.8 \text{ GHz}$	dB		± 0.6	± 1.0
$f_{3 \text{ dB}}$	3 dB Bandwidth	GHz		2.8	
VSWR	Input VSWR $f = 0.1 \text{ to } 3.0 \text{ GHz}$			1.4:1	
	Output VSWR $f = 0.1 \text{ to } 3.0 \text{ GHz}$			1.4:1	
NF	50 Ω Noise Figure $f = 1.0 \text{ GHz}$	dB		6.5	
$P_{1 \text{ dB}}$	Output Power at 1 dB Gain Compression $f = 1.0 \text{ GHz}$	dBm		4.5	
IP_3	Third Order Intercept Point $f = 1.0 \text{ GHz}$	dBm		17.0	
t_{D}	Group Delay $f = 1.0 \text{ GHz}$	psec		125	
V_{d}	Device Voltage	V	4.5	5.0	5.5
dV/dT	Device Voltage Temperature Coefficient	mV/°C		-8.0	

Note:

1. The recommended operating current range for this device is 18 to 40 mA. Typical performance as a function of current is on the following page.

MSA-0270 Typical Scattering Parameters ($Z_0 = 50 \Omega$, $T_A = 25^\circ\text{C}$, $I_d = 25 \text{ mA}$)

Freq. GHz	S_{11}		S_{21}			S_{12}			S_{22}	
	Mag	Ang	dB	Mag	Ang	dB	Mag	Ang	Mag	Ang
0.1	.11	179	12.6	4.26	176	-18.4	.120	1	.12	-8
0.2	.11	174	12.6	4.24	171	-18.6	.117	3	.12	-15
0.4	.10	169	12.5	4.21	162	-18.4	.120	4	.13	-30
0.6	.09	165	12.4	4.17	154	-18.2	.123	5	.14	-44
0.8	.08	161	12.3	4.11	146	-18.2	.123	7	.14	-55
1.0	.06	161	12.2	4.05	137	-18.0	.126	9	.15	-64
1.5	.02	-150	11.7	3.85	116	-17.2	.138	11	.16	-84
2.0	.06	-110	11.1	3.57	96	-16.3	.153	11	.16	-102
2.5	.11	-112	10.3	3.27	82	-15.7	.165	14	.14	-106
3.0	.17	-134	9.3	2.92	65	-15.2	.174	12	.13	-114
3.5	.22	-147	8.2	2.56	48	-14.7	.185	6	.15	-111
4.0	.26	156	7.0	2.23	33	-14.3	.192	3	.19	-107
5.0	.28	179	4.7	1.72	8	-14.0	.199	-6	.27	-107
6.0	.30	143	3.0	1.41	-13	-13.8	.204	-14	.29	-119

A model for this device is available in the DEVICE MODELS section.

Typical Performance, $T_A = 25^\circ\text{C}$ (unless otherwise noted)

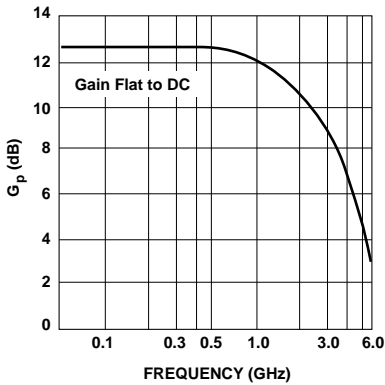

Figure 1. Typical Power Gain vs. Frequency, $T_A = 25^\circ\text{C}$, $I_d = 25 \text{ mA}$.

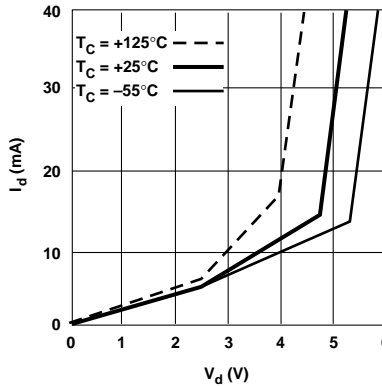

Figure 2. Device Current vs. Voltage.

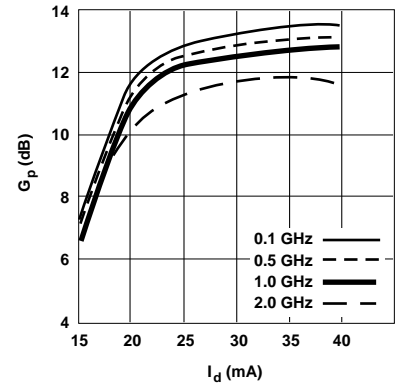

Figure 3. Power Gain vs. Current.

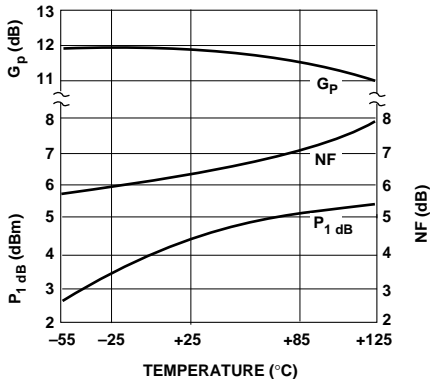

Figure 4. Output Power at 1 dB Gain Compression, NF and Power Gain vs. Mounting Surface Temperature, $f = 1.0 \text{ GHz}$, $I_d = 25 \text{ mA}$.

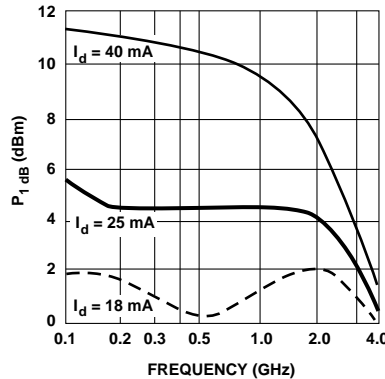

Figure 5. Output Power at 1 dB Gain Compression vs. Frequency.

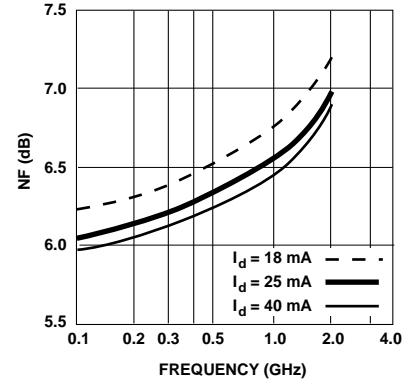
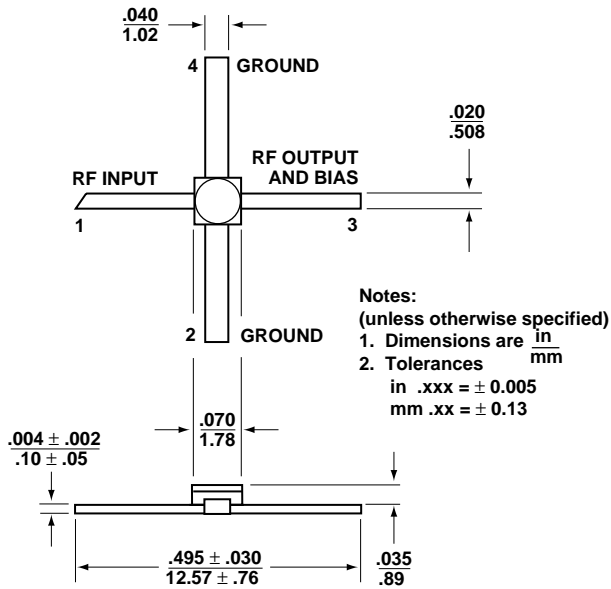

Figure 6. Noise Figure vs. Frequency.

70 mil Package Dimensions



www.hp.com/go/rf

For technical assistance or the location of your nearest Hewlett-Packard sales office, distributor or representative call:

Americas/Canada: 1-800-235-0312 or 408-654-8675

Far East/Australasia: Call your local HP sales office.

Japan: (81 3) 3335-8152

Europe: Call your local HP sales office.

Data subject to change.
Copyright © 1998 Hewlett-Packard Co.

Obsoletes 5965-9698E
Printed in U.S.A. 5966-4954E (12/97)