

Cascadable Silicon Bipolar MMIC Amplifiers

Technical Data

MSA-0235, -0236

Features

- **Cascadable 50 Ω Gain Block**
- **3 dB Bandwidth:**
DC to 2.7 GHz
- **12.0 dB Typical Gain at
1.0 GHz**
- **Unconditionally Stable
($k > 1$)**
- **Cost Effective Ceramic
Microstrip Package**

Description

The MSA-0235 is a high performance silicon bipolar Monolithic Microwave Integrated Circuit (MMIC) housed in a cost effective, microstrip package. This MMIC is designed for use as a general

purpose 50 Ω gain block. Typical applications include narrow and broad band IF and RF amplifiers in industrial and military applications.

The MSA-series is fabricated using HP's 10 GHz f_T , 25 GHz f_{MAX} , silicon bipolar MMIC process which uses nitride self-alignment, ion implantation, and gold metallization to achieve excellent performance, uniformity and reliability. The use of an external bias resistor for temperature and current stability also allows bias flexibility.

Available in cut lead version (package 36) as MSA-0236.

35 micro-X Package^[1]

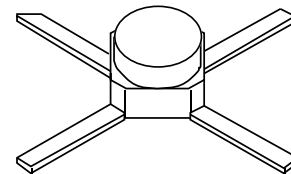

Note:

1. Short leaved 36 package available upon request.

Typical Biasing Configuration

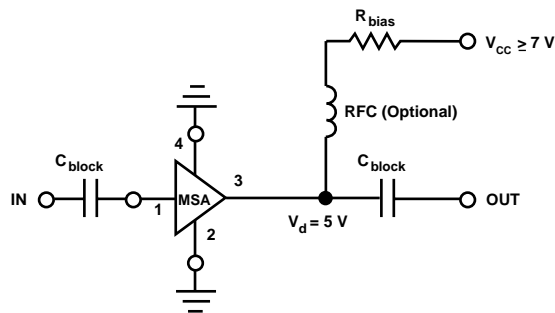

MSA-0235, -0236 Absolute Maximum Ratings

Parameter	Absolute Maximum ^[1]
Device Current	60 mA
Power Dissipation ^[2,3]	325 mW
RF Input Power	+13 dBm
Junction Temperature	200°C
Storage Temperature ^[4]	-65 to 200°C

Thermal Resistance^[2,5]:

$$\theta_{jc} = 145^{\circ}\text{C}/\text{W}$$

Notes:

1. Permanent damage may occur if any of these limits are exceeded.
2. $T_{\text{CASE}} = 25^{\circ}\text{C}$.
3. Derate at 6.9 mW/°C for $T_{\text{C}} > 153^{\circ}\text{C}$.
4. Storage above +150°C may tarnish the leads of this package making it difficult to solder into a circuit.
5. The small spot size of this technique results in a higher, though more accurate determination of θ_{jc} than do alternate methods. See MEASUREMENTS section "Thermal Resistance" for more information.

Electrical Specifications^[1], $T_{\text{A}} = 25^{\circ}\text{C}$

Symbol	Parameters and Test Conditions: $I_{\text{d}} = 25 \text{ mA}$, $Z_{\text{o}} = 50 \Omega$	Units	Min.	Typ.	Max.
GP	Power Gain ($ S_{21} ^2$) $f = 0.1 \text{ GHz}$	dB	11.5	12.5	13.5
ΔGP	Gain Flatness $f = 0.1 \text{ to } 1.6 \text{ GHz}$	dB		± 0.6	± 1.0
$f_{3 \text{ dB}}$	3 dB Bandwidth	GHz		2.7	
VSWR	Input VSWR $f = 0.1 \text{ to } 3.0 \text{ GHz}$			1.2:1	
	Output VSWR $f = 0.1 \text{ to } 3.0 \text{ GHz}$			1.4:1	
NF	50 Ω Noise Figure $f = 1.0 \text{ GHz}$	dB		6.5	
$P_{1 \text{ dB}}$	Output Power at 1 dB Gain Compression $f = 1.0 \text{ GHz}$	dBm		4.5	
IP_3	Third Order Intercept Point $f = 1.0 \text{ GHz}$	dBm		17.0	
t_{D}	Group Delay $f = 1.0 \text{ GHz}$	psec		125	
V_{d}	Device Voltage	V	4.5	5.0	5.5
dV/dT	Device Voltage Temperature Coefficient	mV/°C		-8.0	

Note:

1. The recommended operating current range for this device is 18 to 40 mA. Typical performance as a function of current is on the following page.

Part Number Ordering Information

Part Number	No. of Devices	Container
MSA-0235	10	Strip
MSA-0236-BLK	100	Antistatic Bag
MSA-0236-TR1	1000	7" Reel

For more information refer to PACKAGING section, "Tape and Reel Packaging for Semiconductor Devices."

MSA-0235, -0236 Typical Scattering Parameters ($Z_0 = 50 \Omega$, $T_A = 25^\circ\text{C}$, $I_d = 25 \text{ mA}$)

Freq. GHz	S_{11}		S_{21}			S_{12}			S_{22}	
	Mag	Ang	dB	Mag	Ang	dB	Mag	Ang	Mag	Ang
0.1	.08	170	12.6	4.25	176	-18.6	.118	2	.16	-6
0.2	.08	163	12.5	4.23	171	-18.5	.119	2	.15	-10
0.4	.08	147	12.5	4.19	161	-18.4	.120	4	.15	-21
0.6	.08	130	12.4	4.14	152	-18.3	.121	4	.15	-30
0.8	.07	112	12.2	4.09	143	-18.1	.125	7	.15	-39
1.0	.07	91	12.1	4.02	134	-18.0	.126	10	.15	-46
1.5	.06	47	11.6	3.80	112	-17.3	.137	11	.13	-66
2.0	.03	-1	11.0	3.53	91	-16.3	.153	10	.11	-89
2.5	.03	-115	10.2	3.24	75	-15.4	.169	12	.09	-111
3.0	.09	-157	9.3	2.92	57	-15.1	.176	8	.08	-127
3.5	.16	-175	8.3	2.60	39	-14.4	.190	3	.09	-129
4.0	.20	173	7.2	2.29	23	-14.1	.198	-2	.11	-118
5.0	.27	136	5.2	1.81	-6	-13.5	.211	-11	.15	-117
6.0	.41	94	3.2	1.44	-33	-13.5	.212	-24	.11	-148

A model for this device is available in the DEVICE MODELS section.

Typical Performance, $T_A = 25^\circ\text{C}$

(unless otherwise noted)

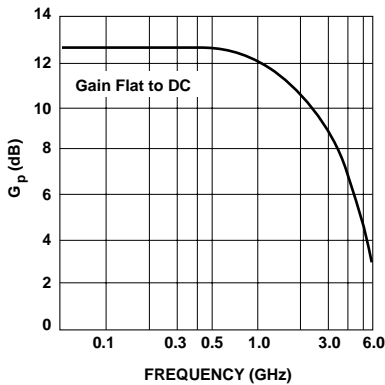

Figure 1. Typical Power Gain vs. Frequency, $T_A = 25^\circ\text{C}$, $I_d = 25 \text{ mA}$.

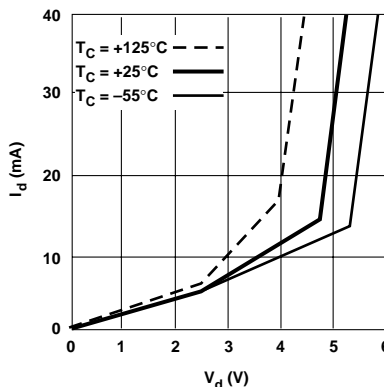

Figure 2. Device Current vs. Voltage.

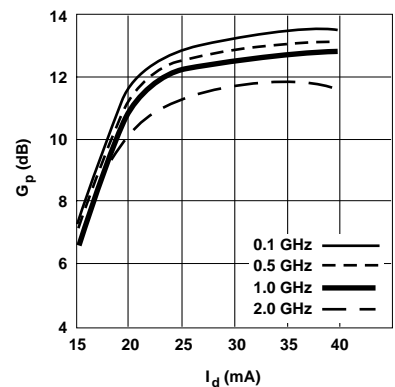

Figure 3. Power Gain vs. Current.

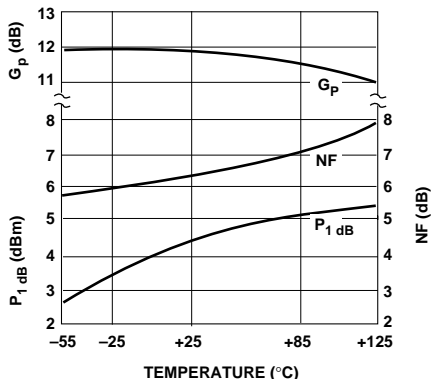

Figure 4. Output Power at 1 dB Gain Compression, NF and Power Gain vs. Mounting Surface Temperature, $f=1.0 \text{ GHz}$, $I_d = 25 \text{ mA}$.

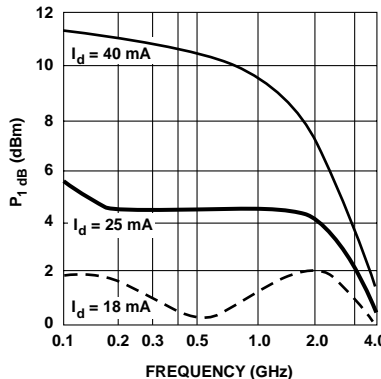

Figure 5. Output Power at 1 dB Gain Compression vs. Frequency.

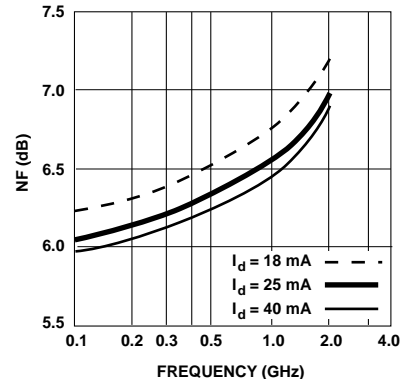

Figure 6. Noise Figure vs. Frequency.

35 micro-X Package Dimensions

