

2 – 26.5 Medium Power Amplifier

Technical Data

HMMC-5027

Features

- **Wide-Frequency Range:**
2-26.5 GHz
- **Moderate Gain:** 7 dB
- **Gain Flatness:** 1 dB
- **Return Loss:**
Input -13 dB
Output -11 dB
- **Low-Frequency Operation Capability:** < 2 GHz
- **Gain Control:**
30 dB Dynamic Range
- **Medium Power:**
20 GHz: P_{-1dB}: 22 dBm
P_{sat}: 24 dBm
26.5 GHz: P_{-1dB}: 19 dBm
P_{sat}: 21 dBm

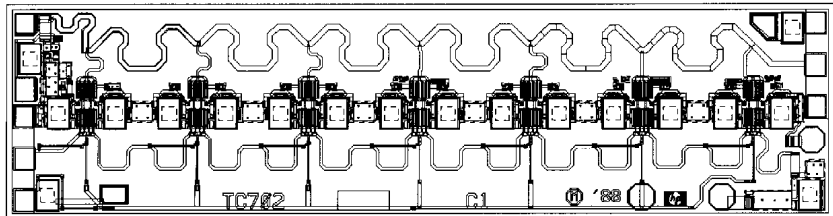

Chip Size: 2980 x 770 μm (117.3 x 30.3 mils)
 Chip Size Tolerance: $\pm 10 \mu\text{m}$ (± 0.4 mils)
 Chip Thickness: $127 \pm 15 \mu\text{m}$ (5.0 ± 0.6 mils)
 Pad Dimensions: 75 x 75 μm (2.95 x 2.95 mils), or larger

Absolute Maximum Ratings^[1]

Symbol	Parameters/Conditions	Units	Min.	Max.
V _{DD}	Positive Drain Voltage	V		8.0
I _{DD}	Total Drain Current	mA		300
V _{G1}	First Gate Voltage	V	-5	0
I _{G1}	First Gate Current	mA	-1	+1
V _{G2}	Second Gate Voltage	V	-2.5	+5
I _{G2}	Second Gate Current	mA	-25	
P _{DC}	DC Power Dissipation	watts		2.4
P _{in}	CW Input Power	dBm		23
T _{ch}	Operating Channel Temp.	°C		+150
T _{case}	Operating Case Temp.	°C	-55	
T _{STG}	Storage Temperature	°C	-65	+165
T _{max}	Maximum Assembly Temp. (for 60 seconds maximum)	°C		+300

Note:

1. Operation in excess of any one of these conditions may result in permanent damage to this device. T_A = 25°C except for T_{ch}, T_{STG}, and T_{max}.

Description

The HMMC-5027 is a broadband GaAs MMIC Traveling Wave Amplifier designed for medium output power and moderate gain over the full 2 to 26.5 GHz frequency range. Seven MESFET cascode stages provide a flat gain response, making the HMMC-5027 an ideal wideband power block. Optical lithography is used to produce gate lengths of $\approx 0.5 \mu\text{m}$. The HMMC-5027 incorporates advanced MBE technology, Ti-Pt-Au gate metallization, silicon nitride passivation, and polyimide for scratch protection.

HMMC-5027 DC Specifications/Physical Properties ^[1]

Symbol	Parameters and Test Conditions	Units	Min.	Typ.	Max.
I_{DSS}	Saturated Drain Current ($V_{DD} = 8.0\text{ V}$, $V_{G1} = 0.0\text{ V}$, $V_{G2} = \text{open circuit}$)	mA	200	300	500
V_p	First Gate Pinch-off Voltage ($V_{DD} = 8.0\text{ V}$, $I_{DD} = 30\text{ mA}$, $V_{G2} = \text{open circuit}$)	V	-2.2	-1.3	-5
V_{G2}	Second Gate Self-Bias Voltage ($V_{DD} = 8.0\text{ V}$, $V_{G1} = 0.0\text{ V}$)	V		1.8 ($0.27 \times V_{DD}$)	
$I_{DSOFF}(V_{G1})$	First Gate Pinch-off Current ($V_{DD} = 8.0\text{ V}$, $V_{G1} = -3.5\text{ V}$, $V_{G2} = \text{open circuit}$)	mA		7	
$I_{DSOFF}(V_{G2})$	Second Gate Pinch-off Current ($V_{DD} = 5.0\text{ V}$, $V_{G1} = 0.0\text{ V}$, $V_{G2} = -3.5\text{ V}$)	mA		10	
θ_{ch-bs}	Thermal Resistance ($T_{backside} = 25^\circ\text{C}$)	$^\circ\text{C/W}$		28	

Note:

1. Measured in wafer form with $T_{chuck} = 25^\circ\text{C}$. (Except θ_{ch-bs} .)

HMMC-5027 RF Specifications^[1],

$T_{op} = 25^\circ\text{C}$, $V_{D1} = V_{D2} = 5\text{ V}$, $V_{G1} = V_{G2} = \text{Open}$, $Z_0 = 50\ \Omega$, unless otherwise noted

Symbol	Parameters and Test Conditions	Units	Min.	Typ.	Max.
BW	Guaranteed Bandwidth ^[2]	GHz	2		26.5
S_{21}	Small Signal Gain	dB	6	7	
ΔS_{21}	Small Signal Gain Flatness	dB		± 0.8	
RL_{in}	Input Return Loss	dB		-13	-10
RL_{out}	Output Return Loss	dB		-11	-10
S_{12}	Reverse Isolation	dB		-28	-25
P_{-1dB}	Output Power @ 1dB Gain Compression	dBm	16.5	19	
P_{sat}	Saturated Output Power	dBm	18.5	21	
H_2	Second Harmonic Power Level ($2 < f_o < 20$) [$P_o(f_o) = 21\text{ dBm}$ or P_{-1dB} , whichever is less]	dBc		-21	-18
H_3	Third Harmonic Power Level ($2 < f_o < 20$) [$P_o(f_o) = 21\text{ dBm}$ or P_{-1dB} , whichever is less]	dBc		-32	-18
NF	Noise Figure	dB		11	

Notes:

1. Small-signal data measured in wafer form with $T_{chuck} = 25^\circ\text{C}$. Large-signal data measured on individual devices mounted in an HP83040 Series Modular Microcircuit Package at $T_A = 25^\circ\text{C}$.
2. Performance may be extended to lower frequencies through the use of appropriate off-chip circuitry. Upper corner frequency $\sim 30\text{ GHz}$.

HMMC-5027 Applications

The HMMC-5027 series of traveling wave amplifiers are designed for use as general purpose wideband power stages in communication systems and microwave instrumentation. They are ideally suited for broadband applications requiring a flat gain response and excellent port matches over a 2 to 26.5 GHz frequency range. Dynamic gain control and low-frequency extension capabilities are designed into these devices.

Biasing and Operation

These amplifiers are biased with a single positive drain supply (V_{DD}) and a single negative gate supply (V_{G1}). The recommended bias conditions for the HMMC-5027 are $V_{DD} = 8.0V$, $I_{DD} = 250\text{ mA}$ or I_{DSS} , whichever is less. To achieve this drain current level, V_{G1} is typically biased between 0V and -0.6V. No other

bias supplies or connections to the device are required for 2 to 26.5 GHz operation. The gate voltage (V_{G1}) MUST be applied prior to the drain voltage (V_{DD}) during power up and removed after the drain voltage during power down. See Figure 3 for assembly information.

The auxiliary gate and drain contacts are used only for low-frequency performance extension below $\approx 1.0\text{ GHz}$. When used, these contacts must be AC coupled only. (Do not attempt to apply bias to these pads.) The second gate (V_{G2}) can be used to obtain 30 dB (typical) dynamic gain control. For normal operation, no external bias is required on this contact and its self-bias potential is between +1.5 and +2.5 volts. Applying an external bias between its open circuit potential and -2.5 volts will adjust the gain while maintaining a good input/output port match.

Assembly Techniques

Solder die-attach using a fluxless AuSu solder preform is the recommended assembly method. Gold thermosonic wedge bonding with 0.7 mil diameter Au wire is recommended for all bonds. Tool force should be 22 ± 1 gram, stage temperature should be $150 \pm 2^\circ\text{C}$, and ultrasonic power and duration should be 64 ± 1 dB and 76 ± 8 msec, respectively. The bonding pad and chip backside metallization is gold.

For more detailed information see HP application note #999 "GaAs MMIC Assembly and Handling Guidelines."

GaAs MMICs are ESD sensitive. Proper precautions should be used when handling these devices.

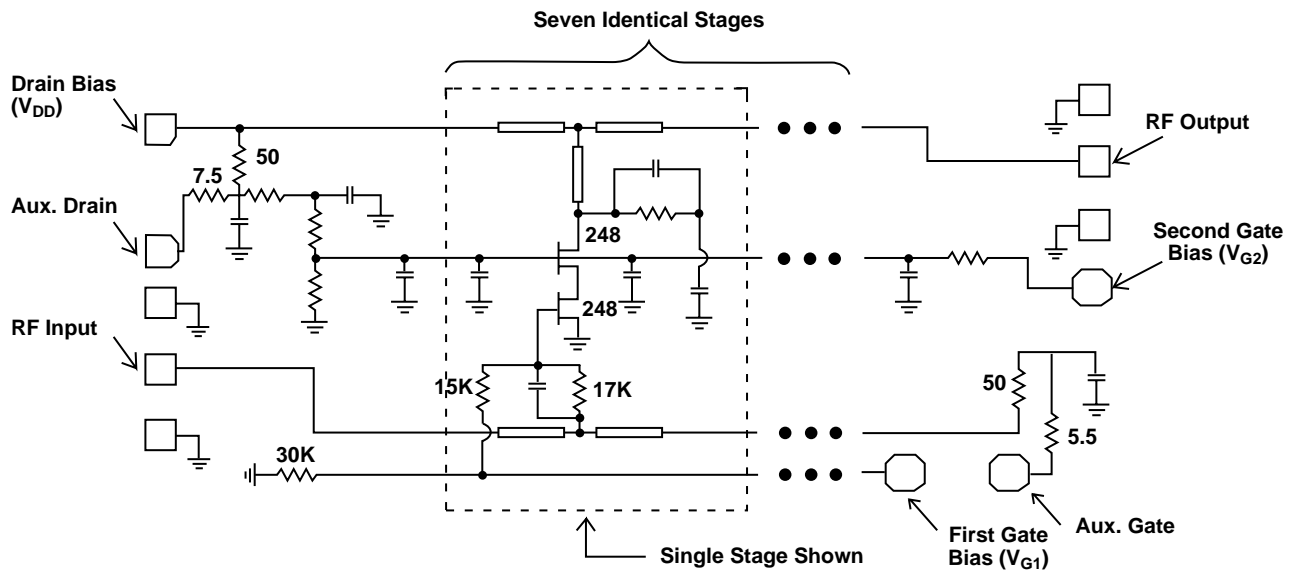

Figure 1. HMMC-5027 Schematic.

Notes:
 FET gate periphery in microns.
 All resistors in ohms. (Ω),
 (or in K-ohms, where indicated)

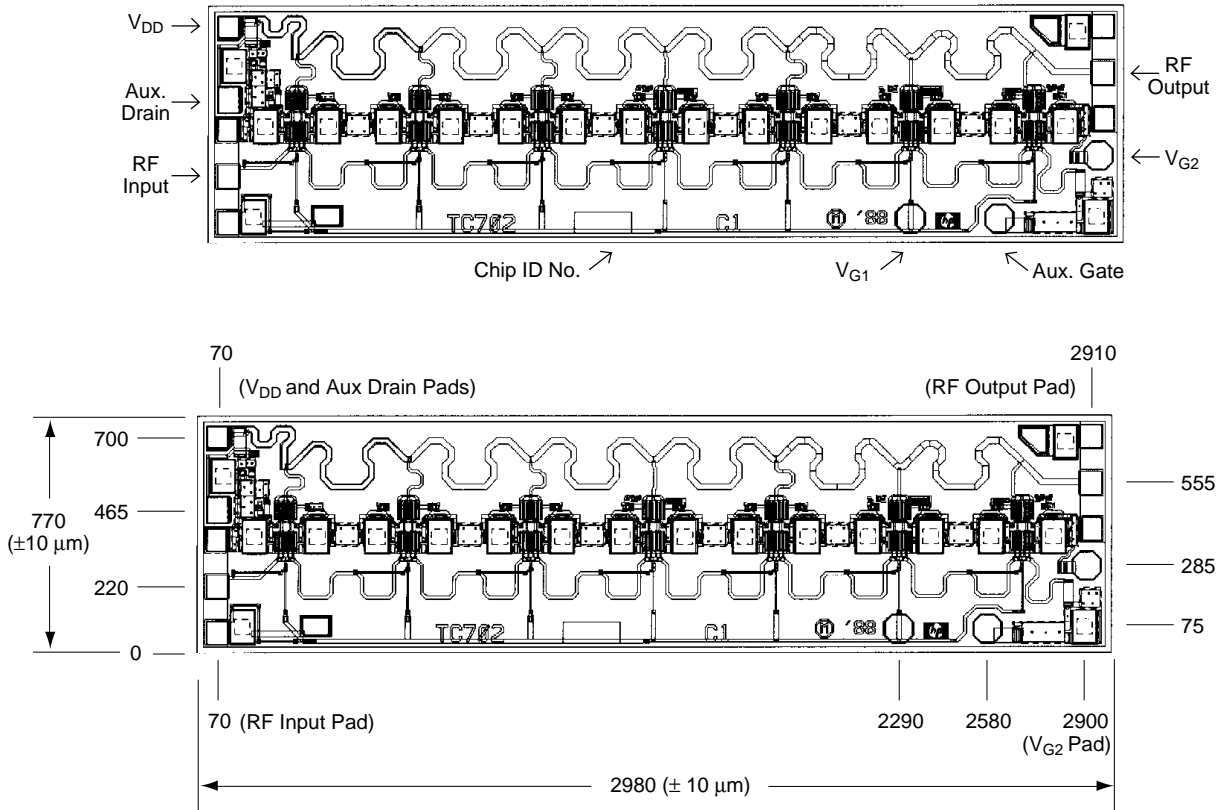

Figure 2. HMMC-5027 Bonding Pad Locations.

Notes:
 All dimensions in microns.
 Rectangular Pad Dim: 75 x 75 μm .
 Octagonal Pad Dim: 90 μm dia.
 All other dimensions $\pm 5 \mu\text{m}$ (unless otherwise noted).
 Chip thickness: $127 \pm 15 \mu\text{m}$.

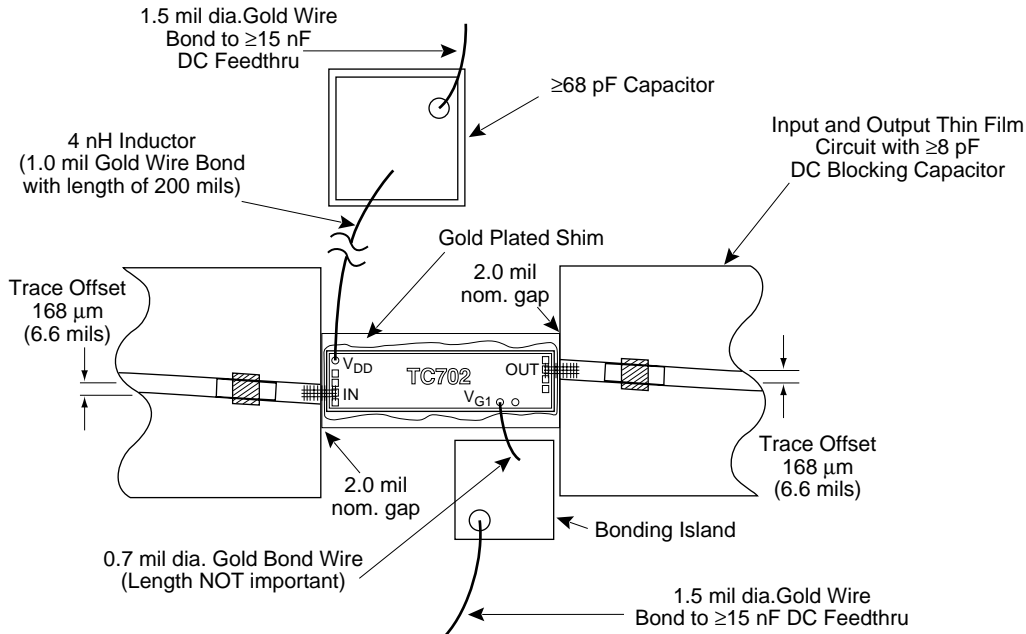

Figure 3. HMMC-5027 Assembly Diagram.

Note:
 Total offset between RF input and RF output pad is 335 μm (13.2 mils).

HMMC-5027 Typical Performance

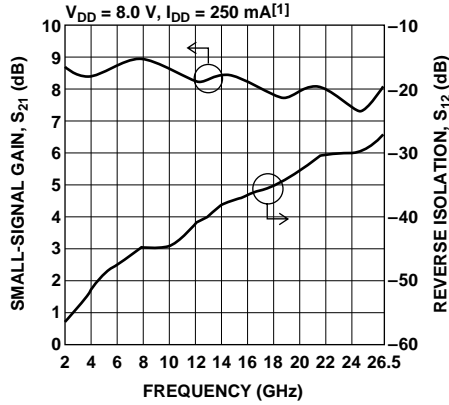

Figure 4. Typical Gain and Reverse Isolation vs. Frequency.

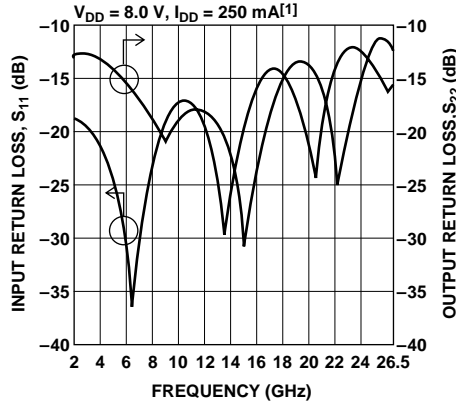

Figure 5. Typical Input and Output Return Loss vs. Frequency.

Typical Scattering Parameters^[1],

($T_{\text{chuck}} = 25^{\circ}\text{C}$, $V_{\text{DD}} = 8.0\text{ V}$, $I_{\text{DD}} = 250\text{ mA}$ or I_{DSS} , whichever is less, $Z_{\text{in}} = Z_{\text{o}} = 50\ \Omega$)

Freq. GHz	S_{11}			S_{21}			S_{12}			S_{22}		
	dB	Mag	Ang	dB	Mag	Ang	dB	Mag	Ang	dB	Mag	Ang
2.0	-18.7	0.116	-139.5	-57.7	0.0013	-165.2	8.7	2.717	116.6	-13.0	0.223	173.5
3.0	-20.1	0.099	-159.0	-54.9	0.0018	144.2	8.4	2.635	94.8	-13.0	0.224	150.0
4.0	-21.5	0.084	-175.7	-52.0	0.0025	154.0	8.3	2.612	72.0	-13.5	0.212	127.1
5.0	-24.6	0.059	167.8	-49.9	0.0032	111.3	8.4	2.634	48.2	-14.0	0.200	101.6
6.0	-32.0	0.025	167.4	-48.2	0.0039	91.3	8.6	2.699	23.3	-15.3	0.171	71.7
7.0	-30.8	0.029	-94.8	-46.9	0.0045	74.9	8.8	2.763	-3.5	-16.9	0.143	39.5
8.0	-22.7	0.073	-103.2	-45.5	0.0053	21.0	8.8	2.768	-30.9	-18.4	0.120	-2.2
9.0	-18.9	0.114	-121.5	-45.2	0.0055	10.3	8.8	2.744	-58.9	-21.3	0.086	-46.9
10.0	-17.2	0.137	-142.6	-44.7	0.0058	-15.5	8.5	2.673	-85.9	-18.9	0.114	-90.7
11.0	-17.4	0.135	-163.9	-43.5	0.0067	-33.4	8.3	2.608	-112.5	-17.9	0.127	-129.6
12.0	-19.3	0.108	175.6	-41.5	0.0084	-45.4	8.2	2.564	-138.5	-18.2	0.123	-162.6
13.0	-25.6	0.052	170.3	-40.6	0.0093	-75.8	8.2	2.578	-164.9	-19.3	0.108	163.4
14.0	-27.0	0.045	-113.0	-38.6	0.0118	-95.9	8.3	2.610	167.1	-22.1	0.078	126.5
15.0	-19.2	0.109	-111.0	-37.8	0.0129	-124.7	8.3	2.605	138.4	-31.2	0.028	56.7
16.0	-15.6	0.167	-127.9	-37.1	0.0139	-149.1	8.2	2.574	108.8	-23.5	0.067	-33.3
17.0	-14.3	0.193	-148.4	-36.3	0.0153	-174.5	8.0	2.510	79.7	-18.1	0.124	-80.7
18.0	-14.8	0.182	-166.6	-35.8	0.0163	164.1	7.8	2.444	50.9	-15.2	0.174	-115.2
19.0	-17.1	0.140	-179.3	-34.7	0.0185	141.5	7.7	2.418	22.1	-13.7	0.207	-147.6
20.0	-21.4	0.086	-166.2	-32.9	0.0227	112.6	7.8	2.466	-7.5	-13.9	0.202	177.9
21.0	-18.4	0.121	-129.5	-31.6	0.0262	80.7	8.1	2.527	-39.9	-16.8	0.145	136.7
22.0	-13.8	0.205	-137.2	-30.9	0.0285	42.7	8.0	2.512	-74.0	-25.3	0.054	66.9
23.0	-12.1	0.247	-152.7	-30.6	0.0296	13.3	7.6	2.395	-108.4	-19.8	0.102	-56.2
24.0	-12.3	0.244	-169.8	-30.3	0.0304	-15.5	7.4	2.344	-142.5	-13.7	0.207	-103.5
25.0	-14.7	0.184	-175.8	-29.7	0.0329	-44.9	7.3	2.315	-175.6	-11.3	0.272	-136.7
26.0	-16.7	0.146	-149.3	-28.5	0.0375	-78.1	7.9	2.469	148.1	-11.7	0.259	-171.3
26.5	-14.1	0.197	-141.6	-28.0	0.0399	-98.5	8.0	2.503	126.9	-13.0	0.223	172.3

Note:

1. Data obtained from on-wafer measurements.

HMMC-5027 Typical Performance

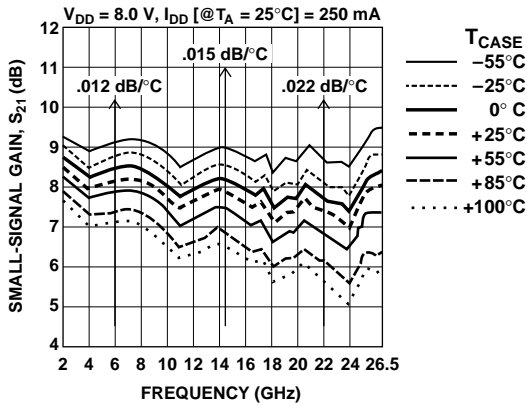

Figure 6. Typical Small-Signal Gain vs. Temperature.

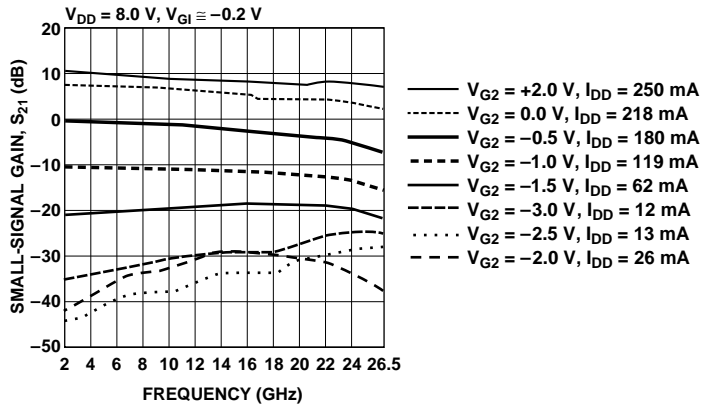

Figure 7. Typical Gain vs. Second Gate Control Voltage.

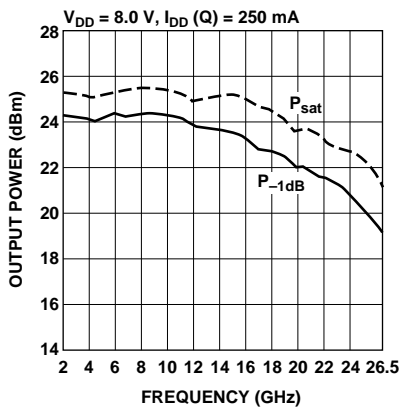

Figure 8. Typical 1 dB Gain Compression and Saturated Output Power vs. Frequency.

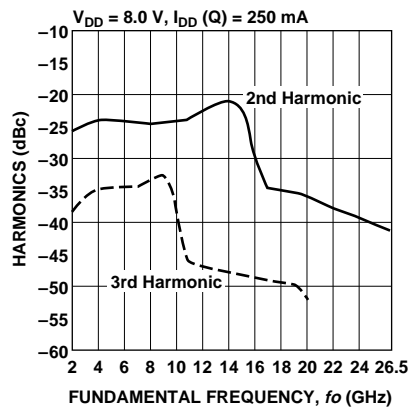

Figure 9. Typical Second and Third Harmonic vs. Fundamental Frequency at $P_{OUT} = +21$ dBm.

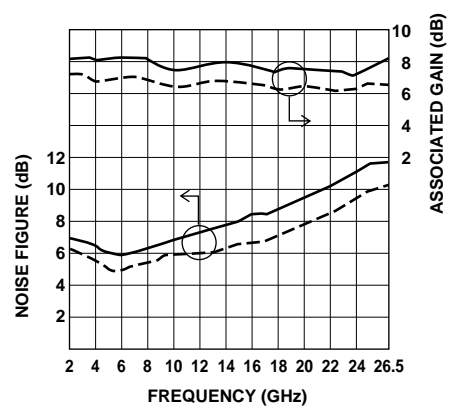

Figure 10. Typical Noise Figure Performance.

— Nominal Bias:
 $V_{DD} = 8.0$ V, $I_{DD} = 250$ mA
 - - - Optimal NF Bias:
 $V_{DD} = 6.5$ V, $I_{DD} = 130$ mA

Note:

- All data measured on individual devices mounted in an HP83040 Series Modular Microcircuit Package @ $T_A = 25^\circ\text{C}$ (except where noted).

This data sheet contains a variety of typical and guaranteed performance data. The information supplied should not be interpreted as a complete list of circuit specifications. In this data sheet the term *typical* refers to the 50th percentile performance. For additional information contact your local HP sales representative.