

DC – 8 GHz Terminated SPDT Switch

Technical Data

HMMC-2007

Features

- **Outputs Terminated in 50 Ω When Off**
- **Frequency Range:** DC-8 GHz
- **Insertion Loss:**
1.2 dB @ 8 GHz
- **Isolation:**
> 70 dB @ 45 MHz
> 35 dB @ 8 GHz
- **Return Loss:**
25 dB (Both Input and Selected Output)
18 dB Unselected Output
- **Switching Speed:**
< 20 μ s (10%-90% RF)
- **P_{-1dB}:** 27 dBm
- **Harmonics (DC Coupled):**
< -80 dBc @ 10 dBm

Description

The HMMC-2007 is a GaAs monolithic microwave integrated circuit (MMIC) designed for low insertion loss and high isolation from DC to 8 GHz. It is intended for use as a general-purpose, single-pole, double-throw (SPDT), absorptive switch. Two series and two shunt MESFETs per throw provide 1.4 dB maximum insertion loss and 38 dB typical isolation at 6 GHz. HMMC-2007 chips use through-substrate vias to provide ground connections to the chip backside and minimize the number of wire bonds required.

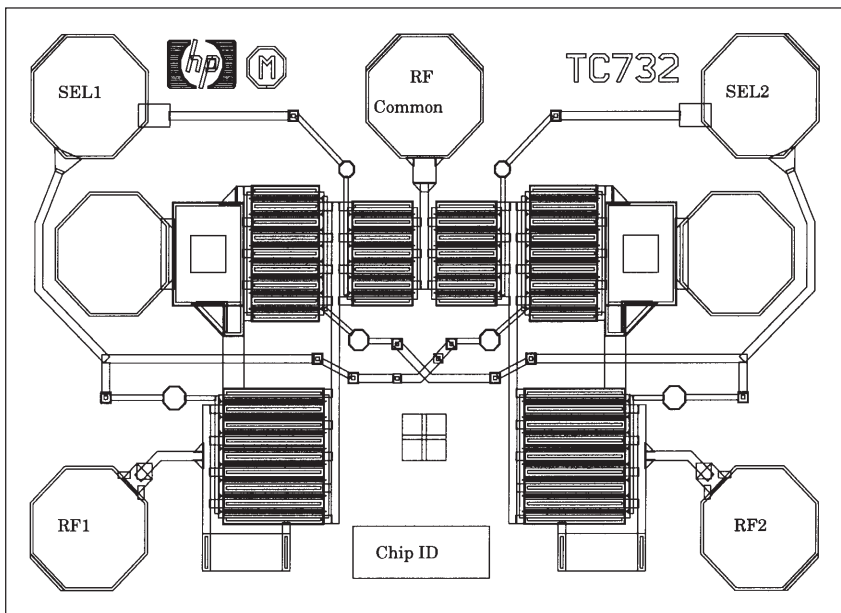

Chip Size: 660 x 960 μ m (25.9 x 37.8 mils)
 Chip Size Tolerance: \pm 10 μ m (\pm 0.4 mils)
 Chip Thickness: 127 \pm 15 μ m (5.0 \pm 0.6 mils)
 Pad Dimensions: 120 x 120 μ m (4.7 x 4.7 mils)

Absolute Maximum Ratings^[1]

Symbol	Parameters/Conditions	Units	Min.	Max.
V _{sel}	Select Voltages 1 and 2	V	-10.5	+10.5
P _{in}	RF Input Power	dBm		27
T _{op}	Operating Temperature	$^{\circ}$ C	-55	+125
T _{STG}	Storage Temperature	$^{\circ}$ C	-65	+165
T _{max}	Maximum Assembly Temp.	$^{\circ}$ C		+200
P _{unsel}	Power into Unselected Output	dBm		27

Note:

1. Operation in excess of any one of these conditions may result in permanent damage to this device. T_A = 25 $^{\circ}$ C except for T_{op}, T_{STG}, and T_{max}.

DC Specifications/Physical Properties, $T_A = 25^\circ\text{C}$

Symbol	Parameters and Test Conditions	Units	Min.	Typ.	Max.
$I_{\text{SEL} -10\text{V}}$	Leakage Current @ -10 V	μA			200
$I_{\text{SEL} +10\text{V}}$	Leakage Current @ +10 V	μA			20
V_p	Pinch-Off Voltage ($V_{\text{SEL}2} = V_p$, $V_{\text{RFout}2} = +2\text{V}$, $I_{\text{RFout}2} = 4\text{mA}$, $V_{\text{SEL}1} = -10\text{V}$, $V_{\text{RFout}1} = \text{open circuit}$, $V_{\text{RFin}} = \text{GND}$)	V	-6.75		-3.00
BV_{gss}	Breakdown Voltage (Test FET w/ $V_D = V_S = \text{GND}$, $I_G = -50\mu\text{A}$)	V			-13.0

RF Specifications, $T_A = 25^\circ\text{C}$, $Z_0 = 50\ \Omega$, $V_{\text{sel-high}} = +10\text{V}$, $V_{\text{sel-low}} = -10\text{V}$

Symbol	Parameters and Test Conditions	Units	Min.	Typ.	Max.
BW	Guaranteed Operating Bandwidth	GHz	DC		8.0
IL	Insertion Loss, RF_{in} to Selected RF_{out} , $f = 6\text{GHz}$, OFF throw	dB		1.1	1.4
ISO	Isolation, RF_{in} to Unselected RF_{out} , $f = 6\text{GHz}$, OFF throw	dB		38	
RL_{in}	Input Return Loss @ 6 GHz	dB		25	
$\text{RL}_{\text{out-ON}}$	Output Return Loss, ON throw @ 6 GHz	dB		25	
$\text{RL}_{\text{out-OFF}}$	Output Return Loss, OFF throw @ 6 GHz	dB		18	
$P_{1\text{dB}}$	Input Power where IL increases by 1 dB	$f_{\text{in}} = 2\text{GHz}$	dBm	27	
t_s	Switching Speed, 10%–90% RF Envelope	$f_{\text{in}} = 2\text{GHz}$	μs	20	

Applications

The HMMC-2007 can be used in instrumentation, communications, radar, ECM, EW, and many other systems requiring SPDT switching. It can be used for pulse modulation, port isolation, transfer switching, high-speed switching, replacement of mechanical switches, and so on.

Assembly Techniques

Die attach should be done with conductive epoxy. Gold thermosonic bonding is recommended for all bonds. The top and bottom metallization is gold. For more detailed information see HP application note #999 "GaAs MMIC Assembly and Handling Guidelines."

GaAs MMICs are ESD sensitive. Proper precautions should be used when handling these devices.

S-Parameters^[1], $T_A = 25^\circ\text{C}$, $Z_0 = 50\ \Omega$, $V_{\text{sel high}} = 0\ \text{V}$, $V_{\text{sel low}} = -10\ \text{V}$

Freq. GHz	S ₁₁			S ₂₁ (Insertion Loss)			S ₃₁ (Isolation)	S ₂₂ (ON Throw)			S ₃₃ (OFF Throw)		
	dB	Mag.	Ang.	dB	Mag.	Ang.	dB	dB	Mag.	Ang.	dB	Mag.	Ang.
0.5	-26.41	0.048	-57.11	-1.08	0.88	-49.06	-67.74	-28.40	0.03	-47.94	-32.26	0.024	47.18
1.0	-27.53	0.042	-113.83	-1.13	0.88	-93.69	-60.55	-24.74	0.05	-117.54	-30.79	0.029	-38.11
1.5	-30.69	0.029	-176.73	-1.18	0.87	-138.08	-56.17	-31.91	0.02	168.76	-30.35	0.030	-64.68
2.0	-32.37	0.024	115.57	-1.21	0.87	177.39	-53.18	-31.31	0.02	119.22	-26.21	0.049	-134.70
2.5	-31.79	0.026	61.35	-1.25	0.87	133.00	-50.38	-28.90	0.03	68.41	-26.38	0.048	151.66
3.0	-30.60	0.030	4.27	-1.30	0.86	88.53	-47.63	-32.95	0.02	-11.68	-25.66	0.052	103.24
3.5	-28.53	0.037	-58.32	-1.33	0.86	44.08	-45.67	-29.26	0.03	-44.21	-22.99	0.071	38.61
4.0	-27.14	0.044	-124.01	-1.34	0.86	-0.53	-44.12	-30.61	0.02	-113.40	-22.41	0.076	-21.25
4.5	-26.46	0.048	172.69	-1.37	0.85	-45.16	-42.68	-32.21	0.02	165.53	-21.68	0.082	-75.25
5.0	-27.03	0.045	107.19	-1.40	0.85	-89.79	-41.45	-36.49	0.01	141.98	-19.88	0.101	-133.81
5.5	-28.64	0.037	32.44	-1.42	0.85	-134.56	-40.28	-34.51	0.01	4.26	-19.89	0.101	167.02
6.0	-29.55	0.033	-59.18	-1.45	0.85	-179.46	-39.16	-32.44	0.02	-100.27	-19.03	0.112	115.49
6.5	-26.88	0.045	-156.32	-1.51	0.84	135.54	-38.12	-27.18	0.04	176.54	-18.28	0.122	56.80
7.0	-23.24	0.069	130.95	-1.56	0.84	90.76	-37.13	-23.83	0.06	122.00	-18.67	0.117	-2.63
7.5	-21.53	0.084	70.91	-1.52	0.84	46.04	-36.36	-21.48	0.08	51.31	-18.61	0.117	-60.32
8.0	-21.21	0.087	15.06	-1.62	0.83	0.47	-35.64	-21.73	0.08	-15.06	-17.65	0.131	-124.25
8.5	-20.92	0.090	-41.26	-1.64	0.83	-44.44	-34.83	-22.22	0.07	-81.88	-16.95	0.142	172.46
9.0	-19.88	0.101	-104.30	-1.66	0.83	-90.23	-34.13	-20.42	0.09	-145.01	-16.07	0.157	115.03
9.5	-18.65	0.117	-175.05	-1.84	0.81	-135.81	-33.62	-18.17	0.12	145.14	-14.94	0.179	59.82
10.0	-17.04	0.141	116.96	-1.90	0.80	179.24	-34.14	-16.31	0.15	85.15	-14.31	0.193	3.39

Note:

1. Three-port-wafer-probed data: Port 1 = RF Input, Port 2 = Selected RF Output (i.e., ON throw), and Port 3 = Unselected RF Output (i.e., OFF throw).

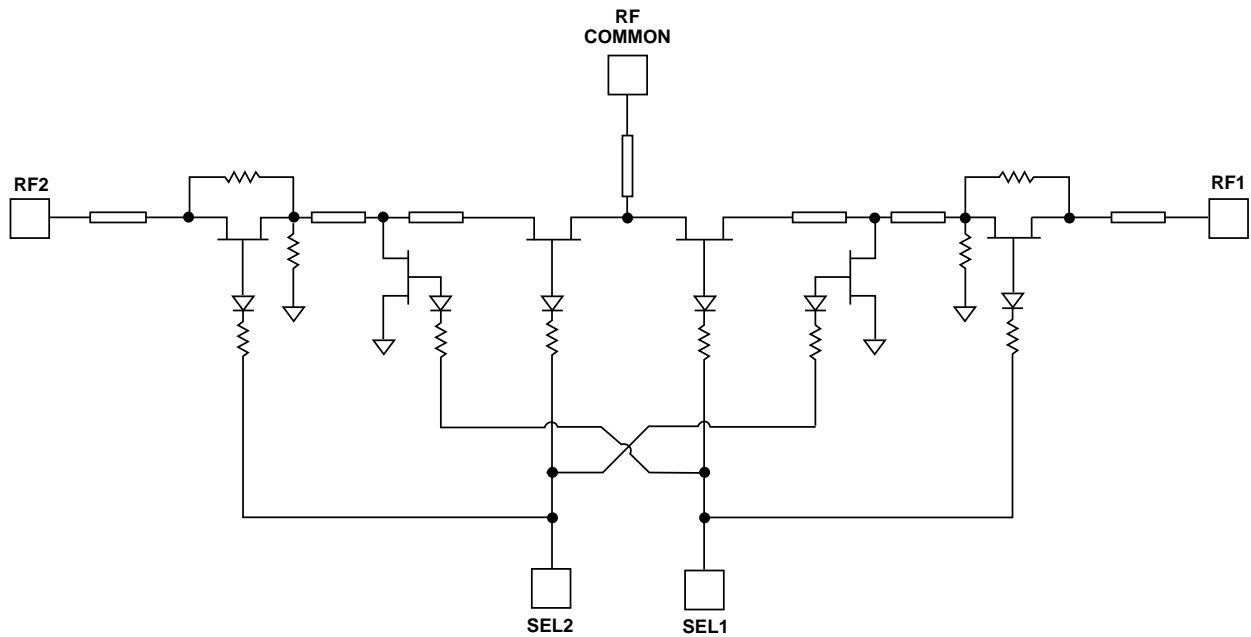

Figure 1. HMMC-2007 Schematic.

Recommended Operating Conditions, $T_A = 25^\circ\text{C}$

Select Line		RF Path	
SEL1	SEL2	RF IN to RF OUT2	RF IN to RF OUT1
+10V	-10V	Isolated	Low Loss
-10V	+10V	Low Loss	Isolated

HMMC-2007 Typical Performance

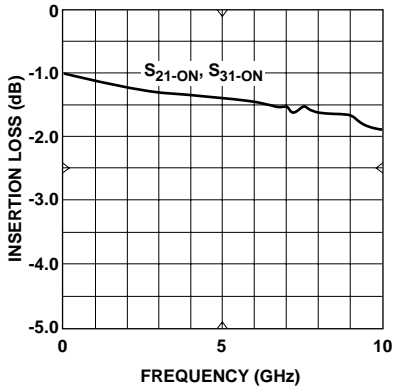

Figure 2. Insertion Loss^[1] vs. Frequency.

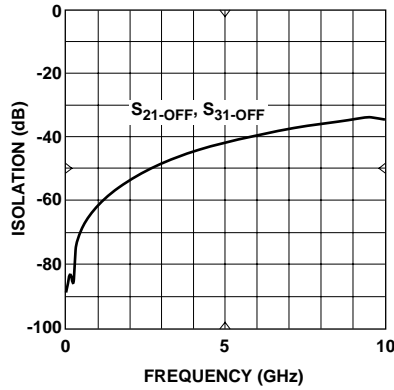

Figure 3. Input-to-Output Isolation^[1] vs. Frequency.

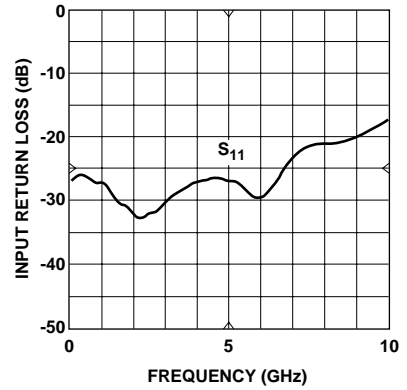

Figure 4. Input Return Loss^[1] vs. Frequency.

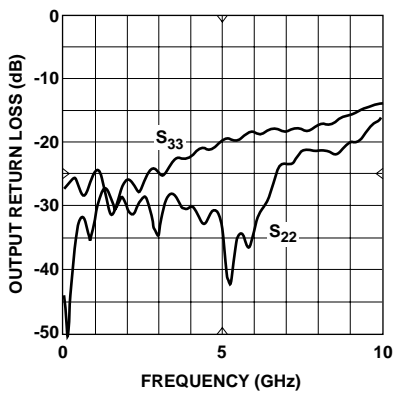

Figure 5. Output Return Loss^[1] vs. Frequency.

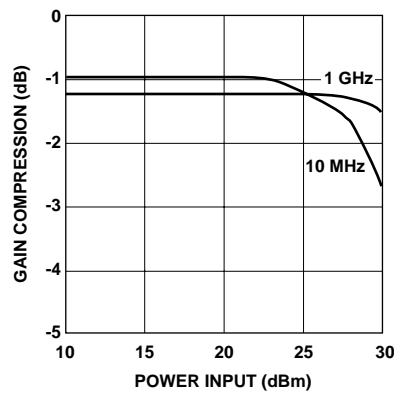

Figure 6. Gain Compression vs. Power Input.

Note:

1. Data taken with the device mounted in modular breadboard package.

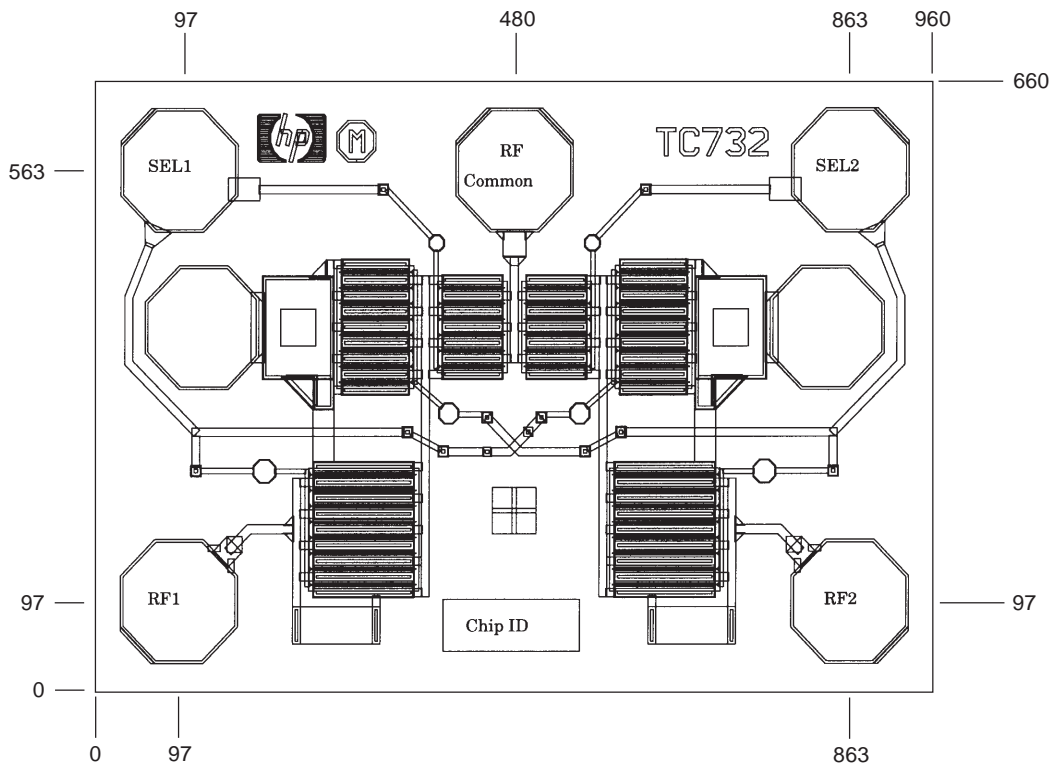

Figure 6. HMMC-2007 Bonding Pad Locations. (Dimensions in micrometers)

Note:

All compression data measured in an individual device mounted in an HP83040 Series Modular Microcircuit Package @ $T_{case} = 25^{\circ}\text{C}$.

This data sheet contains a variety of typical and guaranteed performance data. The information supplied should not be interpreted as a complete list of circuit specifications. In this data sheet the term *typical* refers to the 50th percentile performance. For additional information contact your local HP sales representative.